

Operating Instructions

DVD Recorder

Model No. **DMR-EZ49VEB**

DIGA

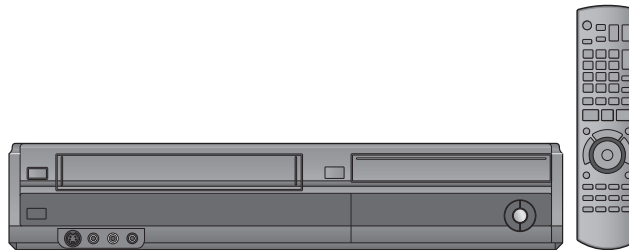

Dear customer

Thank you for purchasing this product.

For optimum performance and safety, please read these instructions carefully.

Before connecting, operating or adjusting this product, please read the instructions completely.

Please keep this manual for future reference.



DVB and the DVB logos are trademarks of the DVB Project.

Notice for DVB functions

This DVD Recorder is for viewing and recording free to view channels only, not Pay TV or encrypted channels unless connected to an external source capable of receiving Pay TV or encrypted channels. This unit does not have an analogue broadcast tuner.

About descriptions in these operating instructions

•Pages to be referred to are indicated as "⇒ ○○".

Region number supported by this unit

Region numbers are allocated to DVD Recorders and DVD-Video according to where they are sold.

- The region number of this unit is "2".
- The unit will play DVDs marked with labels containing "2" or "ALL".

Example:



Web Site: <http://www.panasonic-europe.com>

Model number suffix "EB" denotes UK model.

EB

VQT2J51

Features

Convenient Functions!

Linked operations with the TV

You can enjoy linked operations with the TV and receiver by using VIERA Link or Q Link.

- Linked Operations with the TV (VIERA Link "HDAVI Control™"/Q Link) (⇒ 46)

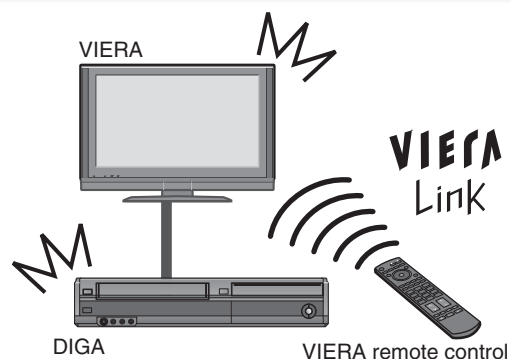

Easy access to various functions

You can access the main function quickly and easily from FUNCTION MENU.

- FUNCTION MENU Display (⇒ 45)

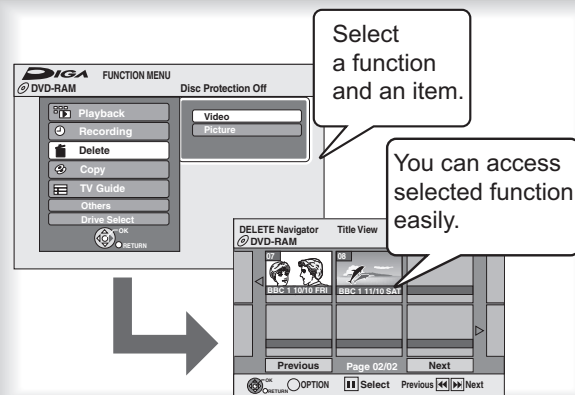

Linked timer recordings with external equipment

You can set the Timer Recordings on Digital STB/ Digital Satellite Receiver when it is connected to this unit with Scart cable.

- Ext Link (⇒ 31)

FREEVIEW™ functions

- Guide Link (⇒ 23)

High Quality Picture

HDMI™ (V.1.3a with Deep Colour)

- Connection with HDMI terminal (⇒ 12)
- Deep Colour (⇒ 92)

Digital Switchover

Starting in late 2007 and ending in 2012, TV services in the UK will go completely digital, TV region by TV region. If you are missing any channels, it may be that they are not available in your area, or that your aerial needs upgrading.

If you have any questions, please call Digital UK on **08456 50 50 50** or visit **www.digitaluk.co.uk**
Digital Switchover will cover a period of several weeks. When it starts some Digital TV programmes will be missing. You will need to retune your DVD Recorder each time this happens to recover your digital programmes.

To retune your DVD Recorder → "DVB Auto Setup by Signal Quality" in the Setup menu (⇒ 67)

Accessories



Please check and identify the supplied accessories. Use numbers indicated in parentheses when asking for replacement parts.
(Product numbers correct as of December 2009. These may be subject to change.)



1 Remote control (N2QAYB000466)

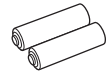

2 Batteries for remote control (R6 Size)

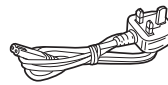

1 AC mains lead (K2CT2YY00003)

● For use with this unit only. Do not use it with other equipment. Also, do not use cords for other equipment with this unit.



1 RF coaxial cable (K1TWACC00001)

Sales and Support Information

Customer Care Centre

- For customers within the UK: 0844 844 3852
- For customers within the Republic of Ireland: 01 289 8333
- Visit our website for product information www.panasonic.co.uk
- E-mail: customer.care@panasonic.co.uk

Direct Sales at Panasonic UK

- For customers: 0844 844 3856
- Order accessory and consumable items for your product with ease and confidence by phoning our Customer Care Centre Monday–Thursday 9.00 a.m.–5.30 p.m., Friday 9.30 a.m.–5.30 p.m (Excluding public holidays).

- Or go on line through our Internet Accessory ordering application at www.pas-europe.com.
- Most major credit and debit cards accepted.
- All enquiries transactions and distribution facilities are provided directly by Panasonic UK Ltd.
- It couldn't be simpler!
- Also available through our Internet is direct shopping for a wide range of finished products, take a browse on our website for further details.

*Interested in purchasing an extended guarantee?
Please call 0870 240 6284 or visit our website
www.panasonic.co.uk/guarantee.*

Caution for AC Mains Lead

For your safety, please read the following text carefully.

This appliance is supplied with a moulded three pin mains plug for your safety and convenience.

A 5-ampere fuse is fitted in this plug.

Should the fuse need to be replaced please ensure that the replacement fuse has a rating of 5-ampere and that it is approved by ASTA or BSI to BS1362.

Check for the ASTA mark  or the BSI mark  on the body of the fuse.

If the plug contains a removable fuse cover you must ensure that it is refitted when the fuse is replaced.

If you lose the fuse cover the plug must not be used until a replacement cover is obtained.

A replacement fuse cover can be purchased from your local dealer.

CAUTION!

IF THE FITTED MOULDED PLUG IS UNSUITABLE FOR THE SOCKET OUTLET IN YOUR HOME THEN THE FUSE SHOULD BE REMOVED AND THE PLUG CUT OFF AND DISPOSED OF SAFELY. THERE IS A DANGER OF SEVERE ELECTRICAL SHOCK IF THE CUT OFF PLUG IS INSERTED INTO ANY 13- AMPERE SOCKET.

If a new plug is to be fitted please observe the wiring code as stated below.

If in any doubt please consult a qualified electrician.

IMPORTANT

The wires in this mains lead are coloured in accordance with the following code:

Blue: Neutral, Brown: Live.

As these colours may not correspond with the coloured markings identifying the terminals in your plug, proceed as follows:

The wire which is coloured Blue must be connected to the terminal which is marked with the letter N or coloured Black or Blue.

The wire which is coloured Brown must be connected to the terminal which is marked with the letter L or coloured Brown or Red.

WARNING: DO NOT CONNECT EITHER WIRE TO THE EARTH TERMINAL WHICH IS MARKED WITH THE LETTER E, BY THE EARTH SYMBOL  OR COLOURED GREEN OR GREEN/YELLOW.

THIS PLUG IS NOT WATERPROOF—KEEP DRY.

Before use

Remove the connector cover.

How to replace the fuse

The location of the fuse differ according to the type of AC mains plug (figures A and B). Confirm the AC mains plug fitted and follow the instructions below.

Illustrations may differ from actual AC mains plug.

1. Open the fuse cover with a screwdriver.

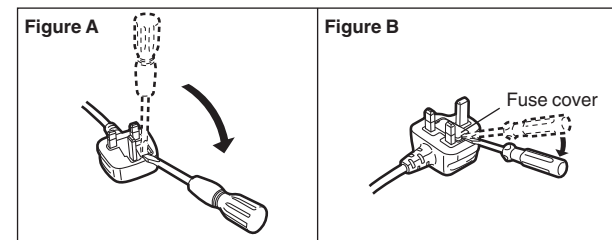

2. Replace the fuse and close or attach the fuse cover.

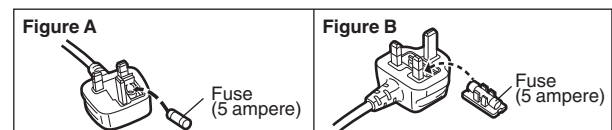

Safety Precautions

Placement

Set the unit up on an even surface away from direct sunlight, high temperatures, high humidity, and excessive vibration. These conditions can damage the cabinet and other components, thereby shortening the unit's service life.

Do not place heavy items on the unit.

Voltage

Do not use high voltage power sources. This can overload the unit and cause a fire.

Do not use a DC power source. Check the source carefully when setting the unit up on a ship or other place where DC is used.

AC mains lead protection

Ensure the AC mains lead is connected correctly and not damaged. Poor connection and lead damage can cause fire or electric shock. Do not pull, bend, or place heavy items on the lead.

Grasp the plug firmly when unplugging the lead. Pulling the AC mains lead can cause electric shock.

Do not handle the plug with wet hands. This can cause electric shock.

Foreign matter

Do not let metal objects fall inside the unit. This can cause electric shock or malfunction.

Do not let liquids get into the unit. This can cause electric shock or malfunction. If this occurs, immediately disconnect the unit from the power supply and contact your dealer.

Do not spray insecticides onto or into the unit. They contain flammable gases which can ignite if sprayed into the unit.

Service

Do not attempt to repair this unit by yourself. If sound is interrupted, indicators fail to light, smoke appears, or any other problem that is not covered in these instructions occurs, disconnect the AC mains lead and contact your dealer or an authorized service centre. Electric shock or damage to the unit can occur if the unit is repaired, disassembled or reconstructed by unqualified persons.

Extend operating life by disconnecting the unit from the power source if it is not to be used for a long time.

Manufactured under license from Dolby Laboratories. Dolby and the double-D symbol are trademarks of Dolby Laboratories.

Manufactured under license under U.S. Patent #'s: 5,451,942; 5,956,674; 5,974,380; 5,978,762; 6,487,535 & other U.S. and worldwide patents issued & pending. DTS and the Symbol are registered trademarks, & DTS 2.0+ Digital Out and the DTS logos are trademarks of DTS, Inc. Product includes software. © DTS, Inc. All Rights Reserved.

U.S. Patent Nos. 6,836,549; 6,381,747; 7,050,698; 6,516,132; and 5,583,936.

This product incorporates copyright protection technology that is protected by U.S. patents and other intellectual property rights. Use of this copyright protection technology must be authorized by Macrovision, and is intended for home and other limited viewing uses only unless otherwise authorized by Macrovision. Reverse engineering or disassembly is prohibited.

HDMI, the HDMI Logo, and High-Definition Multimedia Interface are trademarks or registered trademarks of HDMI Licensing LLC in the United States and other countries.

HDAVI Control™ is a trademark of Panasonic Corporation.

The FREEVIEW service is subject to coverage. An aerial upgrade may be required. The FREEVIEW, FREEVIEW+, FREEVIEW HD and FREEVIEW+ HD words and logos are trade marks of DTV Services LTD. DTV Services Ltd 2002, 2008.

Table of Contents

Getting started

Features	2
Accessories	3
Sales and Support Information	3
Caution for AC Mains Lead	3
Remote Control Information/Unit Care	6
Media Handling	7
Disc Care	7
Inserting Discs	7
Inserting/Removing the USB memory	7
Inserting a video cassette	7
Video Cassette Information	7

Quick Start Guide

Location of Parts/Controls	8
Remote Control	8
The Unit's Display	9
Main Unit	9
Rear Panel	9
Basic Connection	10
Connecting to a Television only	10
Adding a Digital Satellite Receiver:	
Connecting to a Television and a Digital Satellite Receiver	11
Connecting AC mains lead (included)	11
Connecting to a TV with an HDMI (High Definition Multimedia Interface) Cable (not included)	12
Setting the Channels and Clock	13

Disc Handling	15
Usable Discs for Recording and Playback	15
Play-only Discs	16
Discs that Cannot be Played	16
Types of disc for the type of connected TV	16
USB Memory Handling	17
Music files and Still Pictures (JPEG)	18

Basic Operations

Watching Television	19
Watching Digital Satellite Programmes	19
Playback	20
Playing play-only discs	20
Menu Screens on the TV	20
Playing a Video Cassette	21
Recording Television Programmes	22
Timer Recording	23
Copying Titles (One Touch Copy)	24
Copying Titles (VHS → DVD)	24
Copying Titles or Playlists (DVD → VHS)	25
Deleting Titles	26
DELETE Navigator	26
Deleting Titles During Playback	26

Advanced Features

Notes for Recording	27
Advanced Recording	28
DVD Recording Modes and Durations	28
VHS Recording Modes and Durations	28
When the format confirmation screen is displayed	29
When removing a Recorded or Copied Disc	29
Specifying the Recording Time	
—One Touch Recording	29
Direct TV Recording	29
Flexible Recording	30
Playing while you are recording	30
Recording from a Digital Satellite Receiver	31
Manual Recording	31
Linked timer recordings with external equipment	
(SKY Digital STB/digital satellite receiver) — EXT LINK	31
Recording from an External Device	32
Advanced Timer Recording	33
Manual timer recordings	33
Language for broadcast with multi-audio or multi-subtitle	33
To cancel a timer recording in progress	33
If the "Overlapped Timer Recording" screen appears	34
Check, Change, Delete Programmes,	
or Resolve Overlapping	34
To deactivate timer programme	
(e.g. to interrupt a daily or weekly timer programming)	34
Making timer recordings on the television	35
Notes on timer recording	35

GUIDE Plus+ system	36
Using the GUIDE Plus+ list	36
View advertisement	36
Selecting the programme from the desired programme type or category	37
Searching desired programmes on GUIDE Plus+ list by words	37
Advanced Disc Playback	38
Selecting Titles to Play	38
Search	38
Skip	38
Quick View (Play × 1.3)	38
Direct Play	38
Slow-motion Play	39
Frame-by-Frame Viewing	39
Time Slip	39
Manual Skip	39
Create Chapters	39
Advanced Video Cassette Playback	40
Fast-forward/Rewind	40
Slow-motion Play	40
Cue/Review	40
Jet Search	40
Jet Rewind	40
VHS Index Search System (VISS)	40
S-VHS Quasi Playback (SQPB)	40
Repeat Playback	40
Adjusting the Playback Picture	41
Changing Audio during Playback	41
On-screen Display Indicators	41
Playing Music files and Still Pictures (JPEG)	42
Showing the menu screen	42
Playing Music files	42
Playing still pictures	43
Start Slideshow	43
Convenient Functions	45
FUNCTION MENU Display	45
Linked Operations with the TV (VIERA Link "HDAVI Control™"/Q Link)	46
Easy control only with VIERA remote control	47
Information Messages	48
Digital Channel Information	48
Status Messages	49
New Channel Message	49
Entering Text	49
Advanced Editing	
Titles—Editing	50
Accessing the Title View	50
Title Operations	50
Chapters—Creating, Editing	52
Accessing the Chapter View	52
Chapter Operations	52
Creating, Editing and Playing Playlists	53
Accessing the Playlist View	53
Creating Playlists	53
Editing Playlists/Chapters	53
Still Pictures—Editing	55
Accessing the Album (still picture)/Picture View	55
Album (still picture)/Picture Operations	55
Deleting still pictures using DELETE Navigator	56
Copying Titles or Playlists	57
Copying Titles (VHS → DVD)	57
Copying Titles or Playlists (DVD → VHS)	58
Copying a finalised DVD-R, DVD-R DL, DVD-RW (DVD-Video format), +R and +R DL	59
Copying Still Pictures	60

Setting Menus	
Setting On-Screen Display	62
Accessing the On-Screen Display	62
DVD Management	64
Accessing the Management Menus	64
Setup Menu	66
Accessing the Setup Menu	66
Channel Settings	66
Playback/Recording and Picture Settings	68
Sound and Display Settings	69
Connection Settings	70
VHS Settings	71
System Settings	72

Other Settings	
Other Settings	74
Child Lock	74
Using the Unit's Remote Control to Operate the TV	74

Reference	
Additional Connections	75
Adding a VCR: Connecting to a Television and a Video Cassette Recorder	75
Connecting to a Television with Audio/Video Cable (not included)	76
Adding an Amplifier or Receiver	76
Connecting with an HDMI (High Definition Multimedia Interface) Terminal	77

Frequently Asked Questions	78
Setup	78
Discs	78
DVB-T	78
GUIDE Plus+	78
Recording	79
USB	79
Messages	80
On the Unit's Display	80
On the TV	81

Troubleshooting Guide	82
When Other Panasonic Products Respond to this Remote Control	82
To Reset This Unit	82
General Issues: Power	83
General Issues: Displays	83
General Issues: Operation	84
General Issues: GUIDE Plus+	84
General Issues: DVB-T	85
General Issues: VIERA Link	85
General Issues: USB	86
Playback Issues: Picture	86
Playback Issues: Sound	87
Playback Issues: Operation	87
Playback Issues: Music	88
Playback Issues: Still Pictures	88
Playback Issues: VHS Picture	88
Playback Issues: VHS Sound	88
Playback Issues: VHS Play	88
Recording Issues: Recording/Timer Recording /Copying/External input	88
Recording Issues: VHS Recording	89
Editing Issues: DVD	90
Editing Issues: Still Pictures	90
Specifications	91
Glossary	92
Index	Backcover

Remote Control Information/Unit Care

Remote Control Information

About batteries

- Insert so the poles (+ and -) match those in the remote control.

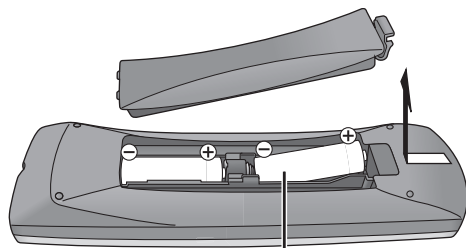

R6/LR6, AA

- Use alkaline or manganese batteries.
- Do not mix old and new batteries.
- Do not use different types at the same time.
- Do not heat or expose to flame.
- Do not leave the battery(ies) in an automobile exposed to direct sunlight for a long period of time with doors and windows closed.
- Do not take apart or short circuit.
- Do not attempt to recharge alkaline or manganese batteries.
- Do not use batteries if the covering has been peeled off.

Mishandling of batteries can cause electrolyte leakage which can damage items the fluid contacts and may cause a fire.

Remove if the remote control is not going to be used for a long period of time. Store in a cool, dark place.

Using the remote control

Aim at the sensor, avoiding obstacles, up to a maximum range of 7 m directly in front of the unit.

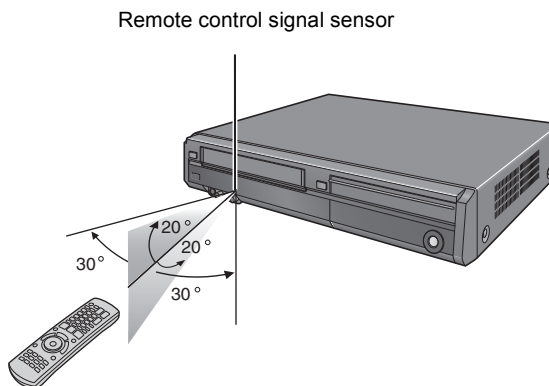

The distance and angles are an approximate.

Unit Care

The precision parts in this unit are readily affected by the environment, especially temperature, humidity, and dust. Cigarette smoke also can cause malfunction or breakdown.

To clean this unit, wipe with a soft, dry cloth.

- Never use alcohol, paint thinner or benzine to clean this unit.
- Before using chemically treated cloth, carefully read the instructions that came with the cloth.

Observe the following points to ensure continued listening and viewing with pleasure.

Dust and dirt may adhere to the unit's lens over time, making it impossible to record or play discs. Use the **DVD lens cleaner** (not included) about once every year, depending on frequency of use and the operating environment. Carefully read the lens cleaner's instructions before use.

DVD lens cleaner: RP-CL720E

- This lens cleaner may not be available for sale in all countries, e.g. not available in Germany, please consult your Panasonic dealer for advice.

To clean the video heads

Dirt on the video heads can cause poor recording and play. If the picture does not improve, use an optional head-cleaning cassette. For choosing the head-cleaning cassette best suited to this unit, please consult your Panasonic dealer for advice. If the problem persists, seek advice from a qualified service person.

Cautions about condensation

Condensation can cause unreliable playback of VHS recordings. Condensation may form in the following cases,

- The unit is brought from cold surroundings into a well-heated room.
- The unit is suddenly brought from cool surroundings, such as an air-conditioned room or car, to a place which is hot and humid.
- During rainy seasons.

In any of the above-mentioned conditions, do not operate the unit for at least 2 hours. The unit is not equipped with a moisture sensor.

- Do not place the unit on amplifiers or equipment that may become hot. The heat can damage the unit.
- The unit should not be installed or operated near large magnets or electromagnetic devices. Such devices can damage pre-recorded VHS recordings.
- Do not place any heavy objects on top of the unit.
- The unit should not be mounted in a vertical position. It's designed to operate in the horizontal position.

DO NOT

This unit

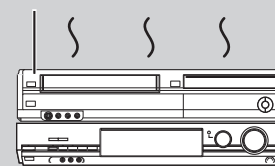

Select a position with good ventilation when installing the unit. Do not block the cooling fan on the rear of the unit.

Before moving the unit, ensure the disc tray and cassette compartment are empty. Failure to do so will risk severely damaging the disc, the video cassette and the unit.

The manufacturer accepts no responsibility and offers no compensation for loss of recorded or edited material due to a problem with the unit or recordable media, and accepts no responsibility and offers no compensation for any subsequent damage caused by such loss.

Examples of causes of such losses are

- A disc recorded and edited with this unit is played in a DVD Recorder or computer disc drive manufactured by another company.
- A disc used as described above and then played again in this unit.
- A disc recorded and edited with a DVD Recorder or computer disc drive manufactured by another company is played in this unit.

Media Handling

Disc Care

Holding a disc

Handle discs by the edges to avoid inadvertently scratching or getting oil from your fingers on the disc. Do not touch the signal surface of discs (the shiny side).

Cleaning discs

Discs are not indestructible and occasionally dirt or condensation may appear. Clean by gently wiping with a soft, dry lint-free cloth in a straight line from the centre of the disc to the edge of the disc.

Return discs to their cases when not in use; this helps to protect against scratches and dirt.

Storing discs

- Do not place or store discs in the following locations:
 - Direct sunlight
 - Very dusty or humid areas
 - Near a heat source
 - Places that undergo extreme shifts in temperature (condensation can occur)
 - Where static electricity or electromagnetic waves occur

Discs to avoid

- Discs that are not perfectly circular in shape
- Warped discs, which may not balance properly in your unit, causing improper operation or damage to the unit
- Cracked discs
- Discs with exposed adhesive (from removed stickers or labels, such as may occur with rental discs or improperly cared-for discs that were previously labelled or re-labelled)

Inserting Discs

- 1 Press [**▲** OPEN/CLOSE] to open the tray.
 - Insert a disc.

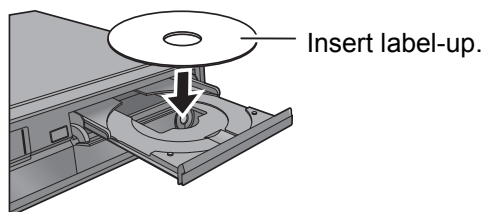

- 2 Press [**▲** OPEN/CLOSE] to close tray.

Notes

- Ensure the disc is flat in the tray.
- When using DVD-RAM or DVD-R, remove the disc from the cartridge. Cartridge discs cannot be used.
- It is not possible to record or play continuously from one side of a double sided disc to the other. You will need to eject the disc and turn it over.

Automatic drive select function

DVD-V VCD CD

- If the unit is stopped, it automatically switches to the DVD drive when a disc is inserted.

Inserting/Removing the USB memory

Inserting the USB memory

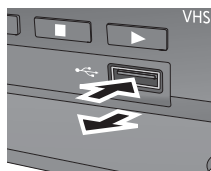

- Before inserting any USB memory to this unit, ensure that the data stored therein has been backed up.
- Check the orientation of the USB connector and insert it straight in.
- Insert an USB device while the unit is stopped, so the "USB device" screen is displayed. Select an item, then press [OK] to switch to the USB-related operations (⇒ 42, 60).

Removing the USB memory

- Complete all USB-related operations and pull the USB memory straight out.
- If a USB memory being accessed is pulled out, then the data may be damaged.

Inserting a video cassette

Insert a video cassette.

(The surface on which you can see a roll of tape should face up.)

The unit is automatically turned on.

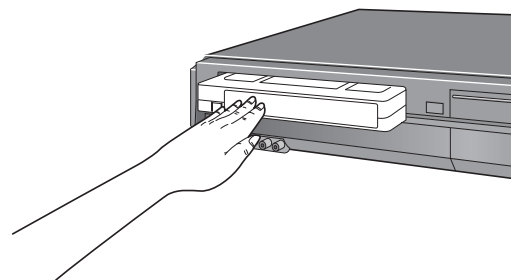

To eject:

From the main unit

- Press [**▲** EJECT] on the main unit.

From the remote control

- Press [DRIVE SELECT] to select VHS drive and then press and hold [**■**] for about 3 or more seconds.

Video Cassette Information

Video cassettes

- Break off the video cassette's tab to prevent accidental erasure. Cover the hole with a double layer of adhesive tape when you want to use the video cassette for recording again.
- You can use video cassettes with the VHS and S-VHS marks, but the unit is unable to make full use of the characteristics of S-VHS video cassettes.

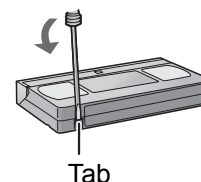

Video cassette care

- Poor quality or damaged video cassettes can cause the heads to become dirty and malfunction. Store your video cassettes carefully and discard them when they become dirty or damaged.
- Never use video cassettes on which juice has been spilled or those that are extremely damaged since this will not only cause the heads to become dirty, but will also make the unit malfunction.

Location of Parts/Controls

Remote Control

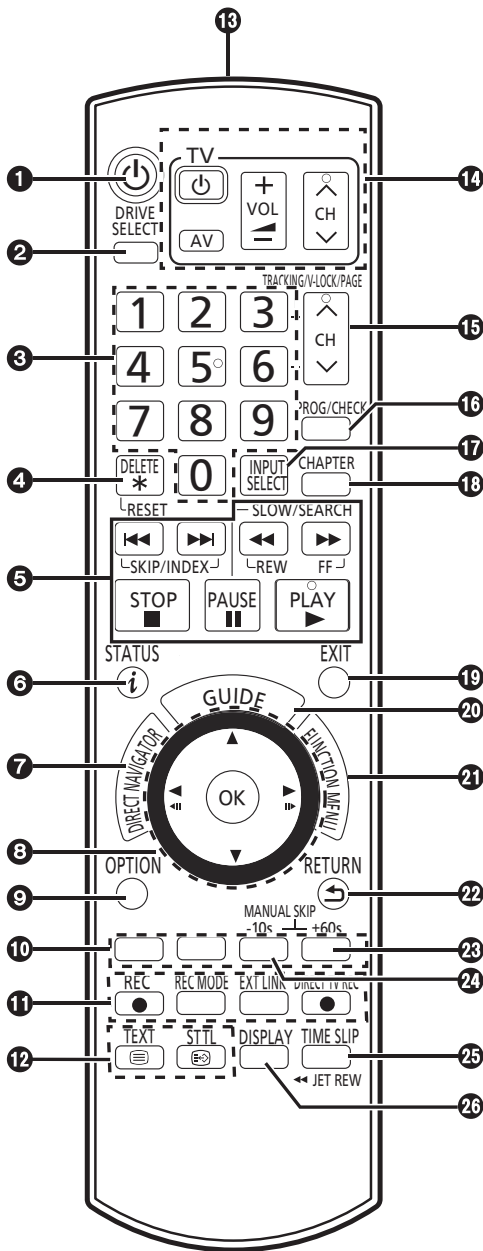

- 1 Turn the unit on or off (⇒ 13)
- 2 Select drive [DVD or VHS] (⇒ 20, 21, 22)
- 3 Select channels and title numbers etc./
Enter numbers (⇒ 13)
- 4 To delete unwanted recorded titles, timer programmes,
or still pictures/Reset the tape counter (⇒ 26, 34, 41, 56)
- 5 Basic operations for recording and play
- 6 Show the digital channel information
/Programme information within GUIDE Plus+ screen
/Show status messages (⇒ 36, 41, 48, 49)
- 7 Show DIRECT NAVIGATOR (⇒ 38, 43)
- 8 Selection/OK, Frame-by-frame (⇒ 13, 39)
- 9 Show OPTION menu
 - for accessing Slideshow or Standby Settings, etc.
 - for playing or editing titles and still pictures, etc. (⇒ 43, 50)
 - for showing advertisements (⇒ 36)
 - for searching for programmes (⇒ 37)
 - for showing Audio Description screen (⇒ 48)
 - for viewing the Top Menu of DVD-Video (⇒ 20)
- 10 Use Colour buttons (Red, Green, Yellow, Blue) according to
on-screen instructions.
 - for switching the DIRECT NAVIGATOR screen (⇒ 38, 43)
 - for switching VIDEO / Playlists (⇒ 58)
 - for GUIDE Plus+ operations (⇒ 36)
 - for deactivating timer programme (⇒ 34)
 - for selecting programme category (⇒ 33, 37, 49)
 - for editing Favourites (⇒ 66)
- 11 Recording function
 - [● REC]: Start recording (⇒ 22)
 - [REC MODE]: Change recording mode (⇒ 22)
 - [EXT LINK]: Linked timer recordings with external equipment (⇒ 31)
 - [● DIRECT TV REC]: Direct TV Recording (⇒ 29)
- 12 DVB function
 - [TEXT (☺)]: Show Digital Teletext service (⇒ 48)
 - [STTL (☺)]: Show subtitles (⇒ 48)
- 13 Transmission window
- 14 TV operations (⇒ 74)
- 15 Channel select/Change pages in the GUIDE Plus+ list
/TRACKING/V-LOCK (⇒ 19, 22, 36, 41)
- 16 Show timer recording list (⇒ 33)
- 17 Input select (Tuner, AV1, AV2, AV3) (⇒ 19, 31, 32)
- 18 Create chapters (⇒ 39)
- 19 Exit the menu screen
- 20 Show the GUIDE Plus+ screen (⇒ 19, 23, 36)
- 21 Show FUNCTION MENU (⇒ 45)
By using the FUNCTION MENU you may access the main
functions (Playback, Recording, etc.) quickly and easily.
- 22 Return to previous screen
- 23 Skip approx. +60s (⇒ 39)
- 24 Skip approx. -10s (⇒ 39)
- 25 Skip the specified time/
Jet rewind button (JET REW) (⇒ 39, 40)
- 26 Show menu for disc playback etc./
Change DVB multi audio (⇒ 62)

The Unit's Display

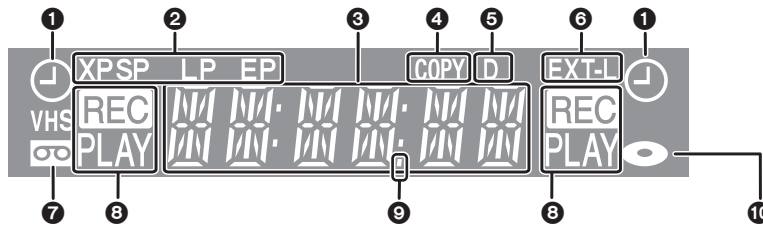

- | | |
|---|---|
| <p>1 Timer recording indicator (⇒ 23)
 On:
 When a timer recording programme is registered and a recordable disc or video cassette is inserted.
 Flashes:
 When the unit cannot record a timer recording programme (e.g., there is no disc or video cassette, etc.).</p> <p>2 Recording mode indicator (⇒ 28)</p> <p>3 Main display section
 Current time/playback counter, various messages</p> <p>4 Copying indicator</p> | <p>5 Digital broadcast indicator
 Lights when the unit is receiving digital broadcast.</p> <p>6 Linked timer recordings with external equipment indicator (⇒ 31)</p> <p>7 Tape indicator</p> <p>8 Recording/Playback indicator</p> <p>9 Remote control visual feedback
 This flashes when it is operated by the remote control.</p> <p>10 Disc indicator
 This indicator lights up when a disc is inserted.</p> |
|---|---|

Main Unit

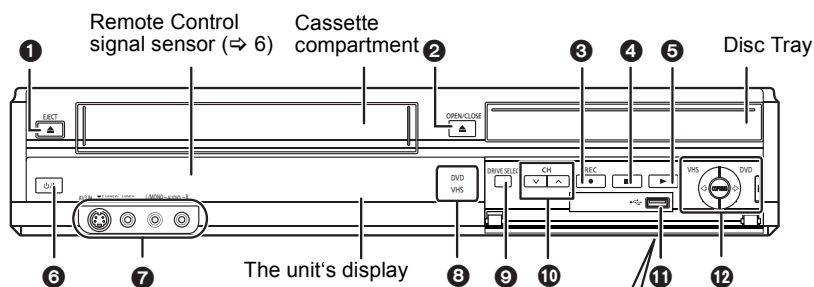

Opening the front panel
 Press down on the part with your finger.

- | | |
|---|--|
| <p>1 Cassette eject button</p> <p>2 Disc tray open/close button (⇒ 20)</p> <p>3 Start recording button (⇒ 22)</p> <p>4 Stop button (⇒ 20, 22)</p> <p>5 Play button (⇒ 20)</p> <p>6 Standby/on switch (⏻/⏻) (⇒ 13)
 Press to switch the unit from on to standby mode or vice versa. In standby mode, the unit is still consuming a small amount of power.</p> | <p>7 AV3 input terminals (⇒ 32)</p> <p>8 DVD/VHS drive indicator (⇒ 20)
 • Lights when the DVD or VHS drive is selected.
 • There is no drive indicator for HDD or SD drive.</p> <p>9 DRIVE SELECT button (⇒ 20, 21, 22)
 • Drive changes each time you press [DRIVE SELECT].</p> <p>10 Channel Select button (⇒ 19, 22)</p> <p>11 USB port (⇒ 7)</p> <p>12 One Touch Copying operation button
 • From VHS to DVD (⇒ 24)
 • From DVD to VHS (⇒ 25)</p> |
|---|--|

Rear Panel

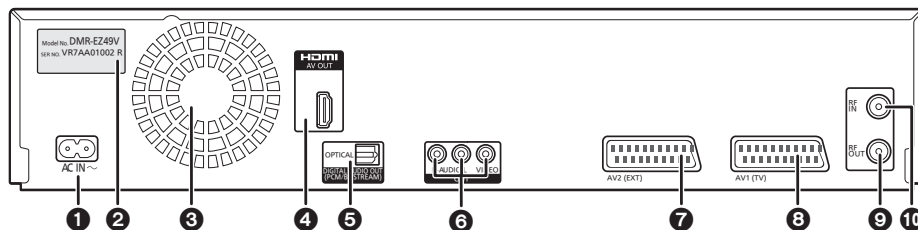

- | | |
|--|---|
| <p>1 AC IN~ = Power supply (⇒ 11)
 Connection for the AC mains lead</p> <p>2 Serial number</p> <p>3 Cooling fan</p> <p>4 HDMI AV OUT terminal (⇒ 12, 77)
 Digital audio and video output terminal</p> <p>5 Digital audio output terminal (⇒ 76)</p> | <p>6 AUDIO/VIDEO output terminals (⇒ 76)</p> <p>7 AV2 (EXT) 21-pin Scart terminal (⇒ 11, 75)
 Connection of an external unit</p> <p>8 AV1 (TV) 21-pin Scart terminal (⇒ 10, 11, 75)
 TV set connection</p> <p>9 Aerial output terminal (⇒ 10, 11, 75)</p> <p>10 Aerial input terminal (⇒ 10, 11, 75)</p> |
|--|---|

Basic Connection

Use of the RF coaxial cable

- Keep the RF coaxial cables as far away as possible from other cables.
- Do not roll up the RF coaxial cables.

Using a fully wired 21-pin Scart cable

- You can use a variety of Q Link functions by connecting the unit to a Q Link compatible television (⇒ 46).
- You can enjoy high-quality viewing by connecting the unit to an RGB compatible television.
 “AV1 Output” in the Setup menu is set to “RGB 1” or “RGB 2” (⇒ 71)
 Make “AV2 Input” settings in the Setup menu (⇒ 71)

- Before connection, turn off the mains for all connected equipment and read the appropriate operating instructions.
BE SURE TO READ THE CAUTION FOR AC MAINS LEAD ON PAGE 3.

Connecting to a Television only

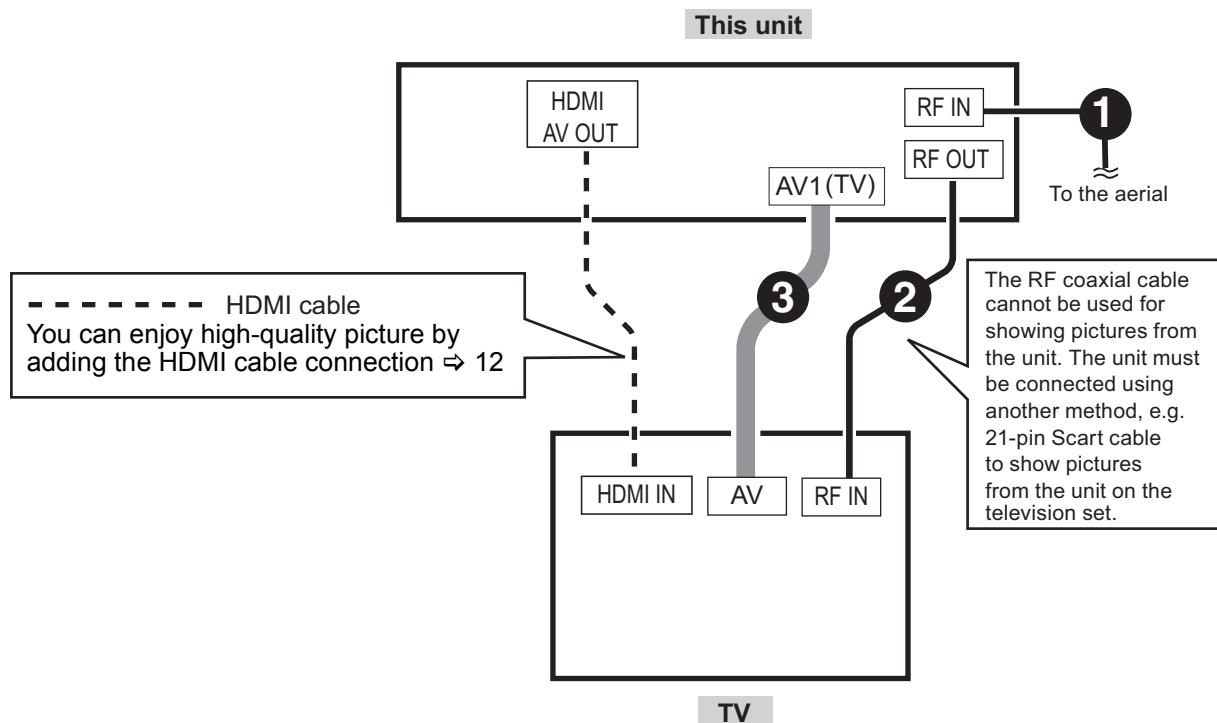

- 1 Aerial cable to the “RF IN” on the unit.
- 2 RF coaxial cable (included) from the “RF OUT” on the unit to the “RF IN” on the TV.
- 3 21-pin Scart cable from the “AV1 (TV)” on the unit to the “AV” on the TV.

21-pin Scart terminal

The 21-pin Scart terminal transmits both input and output signals for picture and sound. TVs equipped with the same type of terminal can be connected here.

This type of terminal is also called Peritel, Euro Connector and Euro AV.

- When the unit is connected to a Q Link-compatible TV with a fully wired 21-pin Scart cable, you can use convenient functions of Q Link.

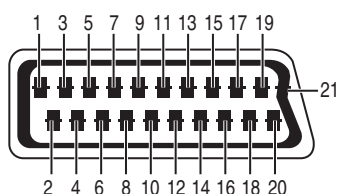

AV1 Scart terminal (TV)

- 1 Audio output CH2 (R)
- 2 Audio input CH2 (R)
- 3 Audio output CH1 (L)
- 4 Audio ground
- 5 Blue ground
- 6 Audio input CH1 (L)
- 7 Blue output
- 8 Switching voltage output
- 9 Green ground
- 10 Q Link control signal
- 11 Green output
- 12 Reserved
- 13 Red ground
- 14 Blanking ground
- 15 Red output/chrominance output
- 16 Blanking output
- 17 Video output ground
- 18 Video input ground
- 19 Video output/luminance output
- 20 Video input
- 21 Ground

AV2 Scart terminal (EXT)

- 1 Audio output CH2 (R)
- 2 Audio input CH2 (R)
- 3 Audio output CH1 (L)
- 4 Audio ground
- 5 Blue ground
- 6 Audio input CH1 (L)
- 7 Blue input
- 8 Switching voltage input
- 9 Green ground
- 10 Reserved
- 11 Green input
- 12 Reserved
- 13 Red ground
- 14 Blanking ground
- 15 Red input/chrominance input
- 16 Blanking input
- 17 Video output ground
- 18 Video input ground
- 19 Video output
- 20 Video input/luminance input
- 21 Ground

Adding a Digital Satellite Receiver: Connecting to a Television and a Digital Satellite Receiver

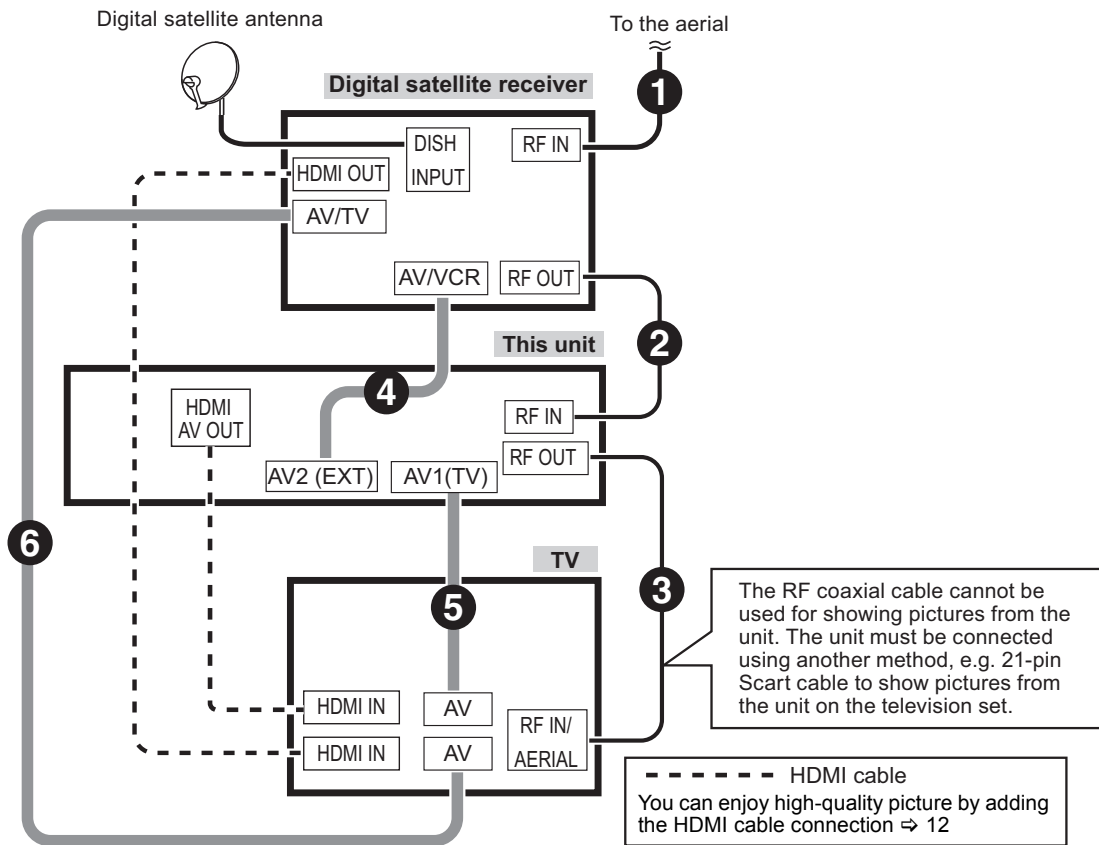

- ❶ Aerial cable to the “RF IN” on the digital satellite receiver.
- ❷ RF coaxial cable from the “RF OUT” on the digital satellite receiver to the “RF IN” on the unit.
- ❸ RF coaxial cable (included) from the “RF OUT” on the unit to the “RF IN” on the TV.
- ❹ 21-pin Scart cable from the “AV/VCR” on the digital satellite receiver to the “AV2 (EXT)” on the unit.
- ❺ 21-pin Scart cable from the “AV1 (TV)” on the unit to the “AV” on the TV.
- ❻ 21-pin Scart cable from the “AV/TV” on the digital satellite receiver to the “AV” on the TV.

To view digital satellite programmes

Refer to “Watching Digital Satellite Programmes” (⇒ 19)

To record digital satellite programmes

Refer to “Recording from a Digital Satellite Receiver” (⇒ 31)

Connecting AC mains lead (included)

Connect only after all other connections are complete.

This unit



When the unit is not to be used for a long time

To save power, unplug it from the household mains socket. This unit consumes a small amount of power, even when it is turned off.

[Approx. 0.5 W (“Power Save in Standby” is activated and “RF OUT (Aerial Signal)” is set to “Off”.)]

After completing the above connections, proceed to the TV Tuning (⇒ 13).

Basic Connection

- You can enjoy high-quality picture by adding the HDMI cable connection to the 21-pin Scart cable connection between this unit and your TV.

Connecting to a TV with an HDMI (High Definition Multimedia Interface) Cable (not included)

When connected to an HDMI compatible unit, an uncompressed digital audio and video signal is transmitted, enabling you to enjoy high quality, digital video and audio with just one cable. When connecting to an HDMI-compatible HDTV (High Definition Television), the output can be switched to 1080p, 1080i or 720p HD video.

- **This unit incorporates HDMI™ (V.1.3a with Deep Colour) technology** that can reproduce greater colour gradation (4096 steps) when connected to a compatible TV.
A lower colour gradation (256 steps), without Deep Colour, will be reproduced if connected to a TV which does not support Deep Colour.
The unit will automatically set appropriate output to suit the connected TV.
- Video sources converted to 1920×1080 resolution, while of high quality, will exhibit somewhat lower subjective image resolution than true, native 1080p full-HD sources. See dealer for details.
- Please use High Speed HDMI Cables that have the HDMI logo (as shown on the cover).
- When setting video output to “1080p”, please use the HDMI cables 5.0 meters or less.

Regarding VIERA Link “HDAVI Control™” function

When connecting with a Panasonic TV (VIERA) or a receiver equipped with the “HDAVI Control” function, linked operations would be possible. [⇒ 46, Linked Operations with the TV (VIERA Link “HDAVI Control™/Q Link)]

- It is recommended that you use Panasonic’s HDMI cable.
Recommended part number: RP-CDHS15 (1.5 m), RP-CDHS30 (3.0 m), RP-CDHS50 (5.0 m), etc.
- Non-HDMI-compliant cables cannot be utilised.

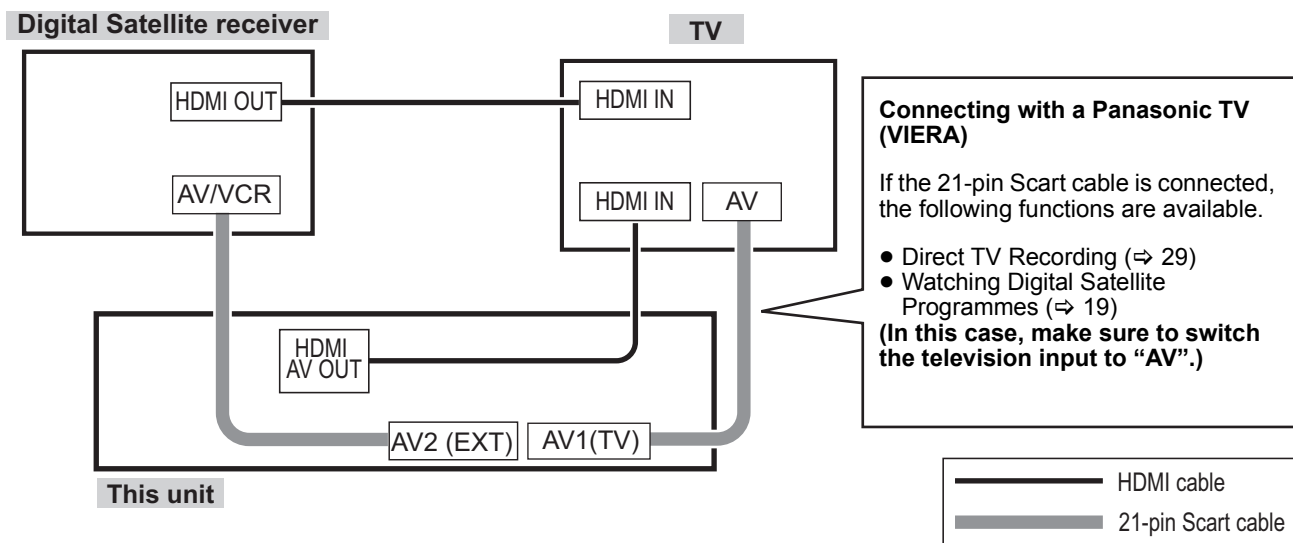

- Set “Digital Audio Output” to “HDMI and Optical” (⇒ 70).
(The default setting is “HDMI and Optical”.)
To enjoy High Quality Video up-converted to 1080p, you need to connect the unit to 1080p compatible HDTV and set “HDMI Video Format” in the Setup menu to “1080p” (⇒ 70).

Notes

- If connecting to equipment that is only compatible with 2 channel audio output, audio with 3 channels or more will be down-mixed (⇒ 92) and output as 2 channels, even if connecting with an HDMI cable (some discs cannot be down-mixed).
- You cannot connect this unit to DVI devices that are incompatible with HDCP.
For display units compatible with HDCP (High-Bandwidth Digital Content Protection) that are equipped with a digital DVI input terminal (PC monitors, etc.):
Depending on the unit, picture may not be displayed properly or at all when connecting with a DVI/HDMI switching cable (audio cannot be output).

Setting the Channels and Clock

Preparation:

- Turn on the mains for the television (and connected equipment) and select the appropriate AV input to suit the connections to this unit.
- These are the first settings you make upon buying the unit. You don't need to make these settings again.

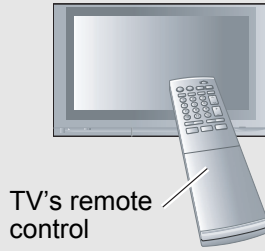

1 to turn the unit on.

DVB Auto Setup starts. The unit will search for the digital terrestrial channels. This takes about 5 minutes.

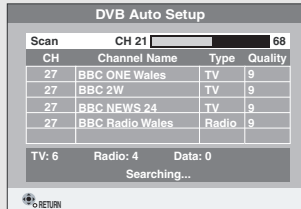

2 Power Save in Standby Function:

▲, ▼ to select "On", "On Timer" or "Off", then

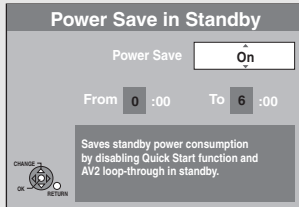

- "On": It will go into the Power Save in Standby mode when the unit is in standby mode.
- "On Timer": Press [▲, ▼, ◀, ▶] to set the start and stop time, then press [OK].
- "Off": It is possible to start quickly from the standby mode. (Quick Start mode)
- "Power Save in Standby" is set to activate during the setting time period.
- The features of the Power Save in Standby function when the unit is in standby mode are as below.

Power Save in Standby	Activated (On / On Timer)	Deactivated (Off)
Power consumption	Approx. 0.5W*2	Approx. 14W
Quick Start*1	Deactivated	Activated
Front display	Turns off (The clock display disappears.)	Stays lit
Watching the picture from the digital satellite receiver connected to the AV2 terminal	Cannot do	Can do

*1 The unit could take over 1 minute to switch ON from standby mode with Quick start deactivated.

This time could be reduced to less than 10 seconds with Quick start activated.

*2 When "RF OUT (Aerial Signal)" is set to "Off" in the Setup menu (⇒ 72)

3 When setup has completed, the confirmation screen appears.



(continued on the next page)



Tips

To cancel Auto-Setup

Press [RETURN ↵].

If the unit displays "No stations found!"

Press [▶] to select "No" and press [OK]. Go to step 2. After you have performed steps 2-1, turn off the unit and confirm the cable or aerial input is connected to the RF IN terminal. Restart the Auto-Setup again (⇒ 67, DVB Auto Setup by Signal Quality).

If the clock setting menu appears or the clock is not correct
Set the clock manually (⇒ 14).

Restarting the Auto-Setup (⇒ 67, DVB Auto Setup by Signal Quality)

To set the channel list best suited to your region (⇒ 67, DVB Auto Setup by Region)

About the screen saver function
When this unit is not operated for approximately 5 minutes while the screen is being displayed, the screen saver may be displayed.
You can turn this function off (⇒ 69, Screen Saver).

Setting the Channels and Clock

- 4** The Owner ID settings screen appears.
▶ and press the numbered buttons to enter your choice of a 4-digit PIN number.

Make a note of the PIN number (don't forget). Owner ID cannot be reset by "Shipping Condition" in the Setup menu (⇒ 73)

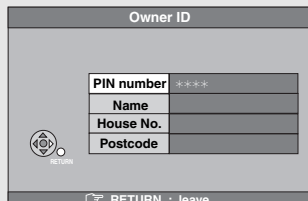

- 5** **OK** to store the PIN number.

- 6** **◀** to select "Yes", then **OK**

The cursor moves to "Name".

- 7** **▶** to enter the name.

- 8** **▲**, **▼** to select a letter, then **▶** to move to next character.

Repeat this to enter the name.

- 9** **OK** to store the name.

- 10** **▼** and **▶** and then repeat steps **8**, **9** to enter and store "House No." and "Postcode".

- 11** **RETURN**

The Owner ID settings screen disappears.

- Auto-Setup for your unit is complete. You can now choose your favourite channels and store them in the required order in the Favourites. (⇒ 66)

Tips

To correct the PIN number

- 1 Press [**◀**, **▶**] to select the digit.
- 2 Press the numbered buttons to enter the digit.

To correct the character

- 1 Press [**◀**, **▶**] to select the character.
- 2 Press [**▲**, **▼**] to correct the character.

To display the Owner ID information on TV

Press and hold [**■**] on the main unit for more than 5 seconds. The PIN number is not displayed. After 30 seconds this menu automatically disappears.

Clock Setting

This unit usually obtains time and date information from digital broadcasts and automatically corrects the time several times a day. However, if the clock is not set correctly, you can set it manually as follows.

- 1** With the unit stopped



- 2** **▲**, **▼** to select "Others", then **OK**

- 3** **▲**, **▼** to select "Setup", then **OK**

- 4** **▲**, **▼** to select "Others", then **▶**

- 5** **▲**, **▼** to select "Clock", then **OK**

- 6** **▲**, **▼** to select Automatic "Off", then **OK**

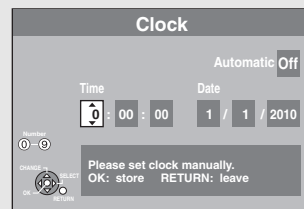

- 7** **◀**, **▶** to select the item you want to change.

The items change as follows:

Hour ↔ Minute ↔ Second ↔ Day ↔ Month ↔ Year

- 8** **▲**, **▼** to change the setting.

You can also use the numbered buttons for setting.

- 9** **OK** to confirm new date and time and to initiate the clock.

- 10** **RETURN**

Tips

- If the clock is set manually, the clock does not automatically correct the time. We recommend you set "Automatic" in the Clock setting menu to "On" in step **6** (⇒ above).

To return to the previous screen

Press [RETURN ↵].

To exit the screen

Press [EXIT].

Usable Discs for Recording and Playback

Disc type	Logo	Data that can be recorded and played	Rewritable	Play on other players*1	Recording 16:9 aspect picture*2	Copy-once recording (CPRM) (⇒ 27)	Standard symbol
DVD-RAM		Video Still picture	○	○	○	○ CPRM (⇒ 92) compatible discs only.	RAM
DVD-R		Video	–	○	○	–	-R before finalisation DVD-V after finalisation
DVD-R DL		Video	–	○	○	–	-R DL before finalisation DVD-V after finalisation
DVD-RW		Video	○	○	○	–	-RW(V) before finalisation DVD-V after finalisation
+R		Video	–	○	– (4:3 aspect)	–	+R before finalisation DVD-V after finalisation
+R DL		Video	–	○	– (4:3 aspect)	–	+R DL before finalisation DVD-V after finalisation
+RW		Video	○	○	– (4:3 aspect)	–	+RW

○: Can do, –: Cannot do

• The explanations concerning video cassettes are indicated by **VHS**.

*1 **-R -R DL -RW(V) +R +R DL**

Finalisation is needed for playback on other equipment (⇒ 65). **RAM** can be played back on Panasonic DVD recorders and DVD-RAM compatible DVD players.

-R DL, **+R DL** or **+RW** can be played back only on equipment compatible with these discs.

*2 For further information (⇒ 27, Notes for Recording)

- **RAM -RW(V) +R +R DL +RW** To use a new disc, formatting is necessary (⇒ 64).
 - **+RW** If the disc failed to play on other equipment, we recommend you create top menu (⇒ 65).
 - Use of Panasonic discs is recommended.
- For available recording times for different discs under different recording modes, see "DVD Recording Modes and Durations" (⇒ 28).

• Formatting and/or recording/initializing constraints may prevent you from playing or recording certain discs.

• Please see specifications (⇒ 91) for compatible disc versions and recording speeds.

Notes

- **RAM** will show an increase in available space whenever a title has been erased.
- **-RW(V)** and **+RW** discs will only show an increase in available space when their last title has been erased.
- **-R -R DL +R +R DL** The discs will show no increase in available space after deleting titles.
- You may not be able to record depending on the condition of the discs and you may not be able to play them due to the condition of the recording.

When playing DVD-R DL (Dual Layer, single-sided) and +R DL (Double Layer, single-sided)



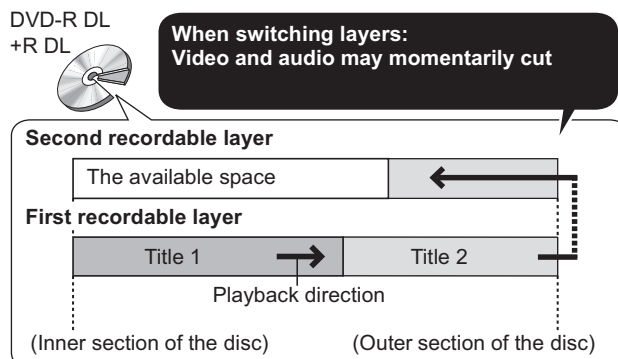





DVD-R DL (Dual Layer, single-sided) and +R DL (Double Layer, single-sided) discs have two writable layers on one side. When playing a title recorded on both layers, the unit automatically switches between layers and plays the title in the same way as a normal programme. However, video and audio may momentarily cut out when the unit is switching layers.



■ Recording Modes and Durations (⇒ 28)

Disc Handling

Play-only Discs

Disc type	Logo	Standard symbol	Uses
DVD-Video	 	DVD-V	High quality movie and music discs
DVD-RW (DVD Video Recording format)		-RW(VR)	DVD-RW* video recorded on another DVD recorder <ul style="list-style-type: none"> You can play programmes that allow One time only recording if they have been recorded onto a CPRM compatible disc. By formatting (⇒ 64) the disc, you can record onto it in DVD-Video format. It may be necessary to finalise the disc on the equipment used for recording.
DVD-R		MP3, JPEG	<ul style="list-style-type: none"> DVD-R* and DVD-R DL* with music recorded in MP3 (⇒ 18) DVD-R* and DVD-R DL* with still pictures recorded in JPEG (⇒ 18)
DVD-R DL			
CD		CD	<ul style="list-style-type: none"> Recorded audio and music (including CD-R/RW*)
		MP3, JPEG	<ul style="list-style-type: none"> CD-R* and CD-RW* with music recorded in MP3 (⇒ 18) CD-R* and CD-RW* with still pictures recorded in JPEG (⇒ 18)
Video CD		VCD	<ul style="list-style-type: none"> Recorded music and video (including CD-R/RW*)
SVCD			

* Play may be impossible on some DVD-RW (DVD Video Recording format), DVD-R, DVD-R DL, CD-R or CD-RW discs due to the condition of the recording.

- You can play still pictures (JPEG) and MP3 format data recorded on DVD-R, DVD-R DL or CD-R/RW. You can also play CD-DA, Video CD and SVCD (conforming to IEC62107) format data recorded on CD-R/RW. Close the session or finalise the disc after recording.
- The producer of the disc can control how discs are played. So you may not always be able to control play as described in these operating instructions. Read the disc's instructions carefully.

Discs that Cannot be Played

- 2.6/5.2 GB DVD-RAM, 12 cm
- 3.95/4.7 GB DVD-R for Authoring
- DVD-R, DVD-R DL, DVD-RW, +R, +R DL recorded on another unit and not finalised (⇒ 92).
- Discs recorded with AVCHD format
- DVD-Video with a region number other than "2" or "ALL"
- DVD-Audio
- Blu-ray, HD DVD
- DVD-ROM, +R 8 cm, CD-ROM, CDV, CD-G, Photo CD, CVD, SACD, MV-Disc, PD, DivX Video Disc
- DVD-RAM with a cartridge (TYPE 1)

Types of disc for the type of connected TV

When you use the discs recorded either PAL or NTSC, refer to this table.

(○: Possible to view, -: Impossible to view)

TV type	Disc	Yes/No
Multi-system TV	PAL	○
	NTSC	○
PAL TV	PAL	○
	NTSC	○*1 (PAL60)
NTSC TV	PAL	-
	NTSC	○*2

*1 If your television is not equipped to handle PAL 525/60 signals the picture will not be shown correctly.

*2 Select "NTSC" in "TV System" (⇒ 70).

- When playing back a disc, ensure that you match the "TV System" setting to the disc (PAL or NTSC) (⇒ 70).

USB Memory Handling

USB memories you can use on this unit

Compatible USB memories	USB memories which are defined as USB mass storage class, and digital cameras that use PTP protocol: – USB memories that support USB 1.0/1.1 and USB 2.0 Full Speed/High Speed. ● USB memories of up to 128 GB can be used. ● USB memories that support bulk only transfer. CBI (Control/Bulk/Interrupt) is not supported. ● Digital Cameras which require additional programme installation when connected to a PC are not supported. ● MTP (Media Transport Protocol) device is not supported. ● A multi-port USB card reader is not supported.	
Format	FAT16 and FAT32 file systems are supported. ● UDF/NTFS/exFAT file system is not supported. ● Depending on the sector size, some files may not work. ● Only the first partition on USB memories with multi-partition is supported.	
Standard symbol	USB	
Data that can be played or copied (⇒ 18) (○: Possible, -: Impossible)		
File format	MP3	Still pictures (JPEG)
Playing	○	○
Instructions	You can play MP3 files recorded with a computer onto the USB memory (⇒ 42).	You can play still pictures recorded with a computer onto the USB memory and copy them to DVD-RAM (⇒ 43, 60).

- Despite meeting the conditions mentioned above, there may be USB memories that cannot be used for this unit.
- This unit's USB port does not support bus-powered USB device.

Music files and Still Pictures (JPEG)

MP3 File Information

Playable media	-R -R DL CD USB
File format	MP3 •Files must have the extension “.mp3” or “.MP3”.
Number of folders (groups or albums)	Maximum number of folders (groups or albums) recognizable: 300 folders (groups or albums) (including the root folder)
Number of files (tracks)	Maximum number of files (tracks) recognizable*1: 3000 files (tracks)
Bit rates	32 kbps to 320 kbps
Sampling frequency	16 kHz/22.05 kHz/24 kHz/32 kHz/44.1 kHz/48 kHz
ID3 tags	compatible (USB)

Still Picture (JPEG*2) Information

Playable media	RAM -R -R DL CD USB
File format	JPEG •Files must have the extension “.jpg” or “.JPG”.
Compatible pixels	Between 34×34 and 6400×6400 (Sub sampling is 4:2:2 or 4:2:0)
Number of folders*3	-R -R DL CD USB Maximum number of folders recognizable: 300 folders RAM This unit can handle a maximum of 300 folders
Number of files*3	-R -R DL CD USB Maximum number of files recognizable*1: 3000 files RAM This unit can handle a maximum of 3000 files
MOTION JPEG	Not supported
PROGRESSIVE JPEG	

• If there is a large amount of still picture data etc. within an MP3 file, play may not be possible.

*1 Total number of recognizable file including MP3, JPEG and other type of files is 4000.

*2 It may take a few moments for still pictures to display.

*3 When there are many files and/or folders, some files may not display or be playable.

Notes

RAM

• Compatible formats: DCF*compliant (Content recorded on a digital camera, etc.)

* Design rule for Camera File system: unified standard established by Japan Electronics and Information Technology Industries Association (JEITA)

-R -R DL CD

• Compatible formats: ISO9660 level 1 or 2 (except for extended formats) and Joliet

• This unit is compatible with multi-session/border (except for DVD-R DL); however, reading or play of the disc may take time if there are a lot of sessions.

• Operation may take time to complete when there are many files (tracks) and/or folders (groups or albums); some files (tracks) may not display or be playable.

• Images recorded at a very high resolution may take a long time to display.

• English alphabetical characters and Arabic numerals are displayed correctly. Other characters may not display correctly.

• The display order on this unit may differ from how the order is displayed on a computer.

• Depending on how you create the disc (writing software), files (tracks) and folders (groups or albums) may not play in the order you number them.

• This unit is not compatible with packet-write format.

• Depending on the recording conditions, the disc may not be played.

Tips

You can play music files (MP3) and still pictures (JPEG) on this unit by making folders as shown below. However depending on the method of writing data (writing software), play may not be in the order you number the folders.

Structure of MP3 folders

-R -R DL CD USB

Prefix with 3-digit numbers in the order you want to play them.

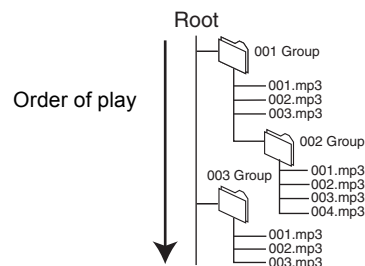

Structure of still pictures (folders)

-R -R DL CD USB

Files inside a folder are displayed in the order they were updated or taken.

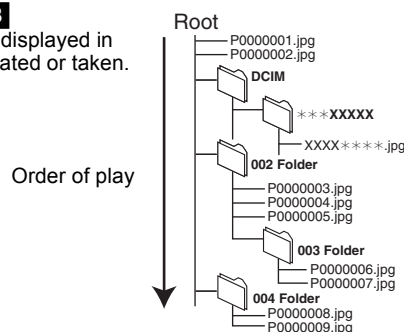

RAM

Folders can be created on other equipment.

* These folders cannot be selected as a copying destination.

• If a folder name or file name has been input using other equipment, the name may not be displayed properly or you may not be able to play or edit the data.

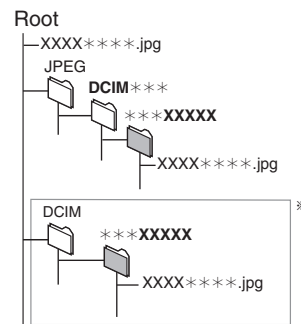

Watching Television

Refer to “GUIDE Plus+ system” (⇒ 36) for detail information.

This DVD recorder has a tuner which allows it to directly receive and record digital terrestrial channels.

Preparation:

- Turn on the television and select the appropriate video input to suit the connections to this unit.

Important:

This unit does not have an analogue broadcast tuner.

1  to turn the unit on.

2  **GUIDE**
– The GUIDE Plus+ list appears.

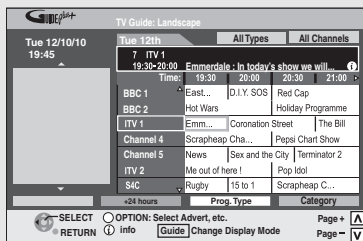

3 ▲, ▼ to select the current programme, then 

4 ▲, ▼ to select “View”, then 

Selecting a Channel without the GUIDE Plus+ system

To select desired channel

Press [▲ ▼ CH].

To directly enter Channels

You can also select channels with the numbered buttons.

e.g., “5”: [0] ⇒ [0] ⇒ [5] or [5] ⇒ [OK]

“15”: [0] ⇒ [1] ⇒ [5] or [1] ⇒ [5] ⇒ [OK]

Tips

- Regarding Digital Channel Information (⇒ 48)
- If New Channel Message appears (⇒ 49)
- To select Audio Description, Digital Teletext and subtitles (⇒ 48)
- To change DVB Multi Audio (⇒ 63, DVB Multi Audio)

Notes

- The GUIDE Plus+ list is not displayed immediately after initial tuning is done.

Watching Digital Satellite Programmes

You can view the digital satellite programmes via this unit by the following method when “Power Save in Standby” is activated, and the digital satellite receiver is not connected to TV.

Preparation:

- Connect a digital satellite receiver to this unit’s AV2 input terminals (⇒ 11).
- Turn on the digital satellite receiver.
- Turn on the television and select the appropriate video input to suit the connections to this unit.

1  to turn the unit on.

2  to select “AV2”.



Tips

- When “Power Save in Standby” is deactivated (⇒ 72), you can watch the digital satellite programme without turning the unit on.

Notes

- You cannot watch digital satellite programmes during timer recording.

Playback



Preparation:





- Turn on the television and select the appropriate video input to suit the connections to this unit.

Playing play-only discs



Refer to “Advanced Disc Playback” (⇒ 38 to 39) for detailed information on playback of discs.

RAM -R -R DL -RW(V) +R +R DL +RW DVD-V -RW(VR) VCD CD

- 1**  to turn the unit on.
- 2**  to select the DVD drive.
 - The DVD indicator lights up on the unit.

e.g.

- 3**  to open the tray (Button located on front of the unit).
 - Insert a disc (⇒ 7) and press [ OPEN/CLOSE] again to close the tray.
- 4** 

Stopping Play

- Press [].
- The stopped position is memorized. (Resume play function)
 - The stopped position is cleared when you press [] several times.

Pausing Play

- Press [].
- Press again to restart play.



Menu Screens on the TV

DVD-V VCD

Generally, menu screens that appear on the TV may be navigated as follows:
e. g.,



DVD-V

, , ,  to select an item, then 

You can sometimes use the numbered buttons to select an item.

VCD

Press the numbered buttons to select an item.



e.g., “5”:  ⇒ , “15”:  ⇒ 



Tips

To return to the menu screen



DVD-V

- 1 Press [OPTION].
- 2 Press [, ] to select “Top Menu” or “Menu” and press [OK].

VCD

Press [RETURN ↵].





Notes

- **RAM -R -R DL -RW(V) +R +R DL +RW -RW(VR)**
Playback starts from the most recent recording.
- **DVD-V VCD**
Playback starts from the point specified by the disc.
- **CD**
Playback starts from the beginning of the disc.
- Depending on the disc type, playing may automatically start without pressing [] (PLAY).
- The unit takes some time to read the disc before play starts.
- DISCS CONTINUE TO ROTATE WHILE MENUS ARE DISPLAYED. Press [] when you finish to preserve the unit’s motor and your television screen.
- If “” appears on the TV, the operation is prohibited by the unit or disc.

Playing a Video Cassette

Refer to “Advanced Video Cassette Playback” (⇒ 40 to 41) for detailed information on playback of video cassette.

VHS

- 1**  to turn the unit on.
- 2**  to select the VHS drive. 
 - The VHS indicator lights up on the unit.
- 3** Insert a cassette (⇒ 7).
 - Play starts automatically if you insert a cassette with the accidental erasure tab removed.
- 4** 

Stopping Play

Press [■].

Pausing Play

Press [⏸].

– Press again to restart play.

Notes

- Tapes are automatically rewound once they reach the end (except during Timer recording, fast forwarding, etc.).
- You may have to adjust the tracking for tapes recorded on other VCRs (⇒ 41). In some cases, the picture quality may still be inferior; this is due to format constraints.
- If “⊗” appears on the TV, the operation is prohibited by the unit or video cassette.

Recording Television Programmes

Refer to “Notes for Recording” (⇒ 27) and “Advanced Recording” (⇒ 28–30) for detail information on recording.

RAM -R -R DL -RW(V) +R +R DL +RW VHS

Preparation:

- Turn on the television and select the appropriate video input to suit the connections to this unit.
- **RAM** If the disc is protected, release protection (⇒ 64).
- **VHS** Ensure accidental erasure tab is intact.

1  to turn the unit on.

2  to select the drive (DVD or VHS).

3 Insert a disc or video cassette.
 – Insert a disc or video cassette with enough remaining blank space (⇒ 7).
 – When the format confirmation screen is displayed (⇒ 29).

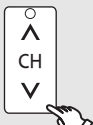
4  to select desired channel.



- To select with the numbered buttons (⇒ 19).
- When no channel setting is performed on the unit and broadcast is recorded directly from the digital satellite receiver, select a channel on the connected equipment, then press [INPUT SELECT] to select “AV2”.

5  to select the recording mode. (⇒ 28)

e.g.,

Recording Mode	
Rec Mode	Remain
XP	0:16
SP	0:32
LP	1:05
EP	2:11

6  to start recording.



Elapsed recording time

Pausing Recording

Press [II].

- Press again to restart recording. (The title is not divided.)

Stopping Recording

Press [■].

Tips

- If a programme to record has subtitles, Audio Description or multiple audio, you can record with these items. They cannot be switched after recording.
 - **To record with subtitles**
Before starting the recording, show the subtitles (⇒ 48). If the programme has multiple subtitle, select the desired language (⇒ 67).
 - **To record with Audio Description**
Before starting the recording, turn on the Audio Description and set the volume (⇒ 48).
 - **To record with the selected audio**
Before starting the recording, select the desired audio channel or language, if the programme has multiple audio channel or language (⇒ 63, 67).
- (Except for **VHS**) To record sound using LPCM (XP mode only):
Set the “Audio Mode for XP Recording” to “LPCM” in the Setup menu (⇒ 69)



Notes

- **RAM -RW(V) +R +R DL +RW** To use a new disc, formatting is necessary. (⇒ 29, 64)
- **-R -R DL -RW(V) +R +R DL +RW** It takes about 30 seconds for the unit to complete recording management information after recording finishes.
- You cannot change the channel or recording mode during recording.
- This unit cannot record NTSC signals to discs that already have PAL signal recordings.
- Depending on the type of disc used for recording or the type of broadcast, there may be restrictions on the title you are trying to record. (⇒ 27)
- **VHS**
 - Even if the video cassette is labelled “S-VHS”, it is not possible to record in the S-VHS system with this unit. This unit records in the normal VHS system.
 - When recording is paused for 5 minutes or more, the unit returns to stop.

Timer Recording

What is FREEVIEW™?

FREEVIEW is the function that enables timer recordings to be controlled by the signal sent from the broadcaster. "Guide Link" is available.

"Guide Link" – If you set a timer recording from the TV Guide, the recording's start and stop times can be controlled by the broadcaster, e.g. delayed start.

This is indicated by "Guide Link" in the Timer Recording screen in step ② (⇒ below).

If you set a timer recording from the TV Guide, the recording's start and stop times are controlled by the signal sent from the broadcaster. If the signal is not sent correctly, the recording may lack the beginning or the ending part of the programmes.

In order to make the timer recording work successfully, we recommend you set the start time earlier and the end time later by some minutes, up to a maximum of 10 minutes for Guide Link to function.

e.g. When you set the timer recording for a programme that will start at 10:00 and end at 11:00, set "9:58" and "11:05" in step ③ (⇒ below).

RAM -R -R DL -RW(V) +R +R DL +RW VHS



Preparation:

- Turn on the television and select the appropriate video input to suit the connections to this unit.
- Turn on this unit.
- Insert a disc or video cassette that you use for recording (⇒ 7).
- **RAM** If the disc is protected, release protection (⇒ 64).
- **VHS** Ensure accidental erasure tab is intact.
- Confirm that the clock on the unit's display is set to the correct time.

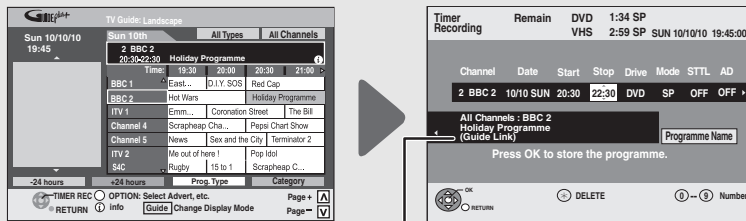
- 1**  – The GUIDE Plus+ list appears.
- 2**  to select the future programme, then 



"Guide Link" is displayed here.

- 3** Confirm the programme (start and end time) by TV magazine, etc. and correct if necessary using  then 



Timer icon

- The settings are stored and the timer programme is on.
- The timer icon is displayed.
- "Ⓢ" lights on the unit's display to indicate timer recording standby has been activated.
- Repeat steps ②–③ to programme other recordings.
- Press [⏻] to turn the unit off.

Notes

- **RAM -RW(V) +R +R DL +RW** To use a new disc, formatting is necessary. (⇒ 29, 64)
- The GUIDE Plus+ list is not displayed immediately after initial tuning is done.
- The GUIDE Plus+ system will not work if the clock is not set correctly.
- If "NTSC" has been selected for "TV System" (⇒ 70), the GUIDE Plus+ system cannot be used.
- "Guide Link" will not be displayed and will not function under the following conditions.
 - Timer programmes set manually (⇒ 33).
 - Timer programmes set from the TV Guide are modified or start/stop time changed by more than 10 minutes from original time.
- "FR" recording mode is not available when the timer programme is controlled by "Guide Link".
- The receipt of the GUIDE Plus+ system data is only possible via the aerial input of this unit. The receipt of the TV Guide data via externally connected satellite receivers is not possible.
- If you set a timer recording that will overlap with other timer recordings, the "Overlapped Timer Recording" screen appears to help you resolve the overlapping. Follow the on-screen instructions.
- Simultaneous recording to both DVD and VHS is not possible.



Tips

- To check programmes (⇒ 34)

- To cancel a timer recording programming

- 1 Press [▲, ▼, ◀, ▶] to select the programme (the timer icon is displayed) and press [OK].
- 2 While "Delete" is selected, press [OK].
- 3 Press [◀, ▶] to select "Yes" and press [OK].
 - The timer icon disappears.

- To record sound using LPCM (XP mode only): Set the "Audio Mode for XP Recording" to "LPCM" in the Setup menu (⇒ 69)

Copying Titles (One Touch Copy)

Refer to “Copying Titles or Playlists” (⇒ 57 to 59) for detail information on copying.

Copying Titles (VHS → DVD)

Programmes are automatically copied onto the disc from the location of playback at the time when the copying of the tape starts.

VHS → **RAM** **-R** **-R DL** **-RW(V)** **+R** **+R DL** **+RW**

Preparation:

- Turn on the television and select the appropriate video input to suit the connections to this unit.
- **RAM** If the disc protected, release protection (⇒ 64).
- Insert a disc with enough space for recording.
- Select the DVD recording mode (⇒ 28).
- Insert the video cassette containing the programme to be copied.
- Press [▶] (PLAY) to play the video cassette and then press and hold [STTL] for about 5 or more seconds to select the audio type you wish to record.
- Stop the tape at the point where you want to start copying from.

On the main unit

- 1 While both DVD and VHS are stopped

Press and hold for about 3 seconds.

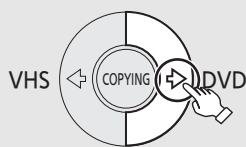

-R **-R DL** **-RW(V)** **+R** **+R DL**

- 2a  to copy and automatically finalise when done (see page 65 for more information on finalising).
–If you press [■], you can cancel copying.

- Or -

- 2b  to copy without finalising.
–If you press [■], you can cancel copying.

- Check if copying starts properly (“COPY” lights on the unit’s display).
- Copying is automatically completed when the tape reaches its end or the disc becomes full.

Tips

•Dividing a title to be copied

When copying from VHS to DVD, titles on the DVD are divided according to index signals detected on the tape.

- Titles that are too short may not be divided correctly.
- The recording time may become longer than the original title depending on the number of index signals.

•To cancel copying in the middle

Press [■].

- You can also press and hold [RETURN] for about 3 or more seconds to cancel copying in the middle. However, you cannot stop finalising after it has started.

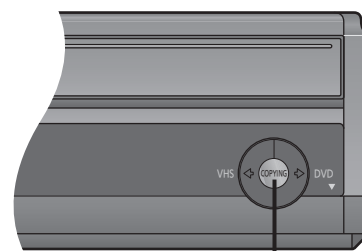

COPYING indicator



Notes

- **-R** **-R DL** **-RW(V)** **+R** **+R DL**
If copying doesn't complete due to shortage of disc space or other reasons, finalising won't start.
- When copying doesn't start, the “COPYING” indicator on the main unit blinks for about 7 seconds. Check if the unit is properly prepared.
- Titles are copied at normal speed.

Copying Titles or Playlists (DVD → VHS)

All titles on the disc are automatically copied onto the tape.

RAM -R -R DL -RW(V) -RW(VR) +R +R DL +RW → VHS

Preparation:

- Turn on the television and select the appropriate video input to suit the connections to this unit.
- **VHS** Ensure accidental erasure tab is intact.
- Insert a video cassette with enough space for recording. Stop the tape at the point where you want to start copying to.
- Select the VHS recording mode (⇒ 28).
- Insert the disc containing the programme to be copied.
- **RAM -RW(VR)** Press and hold [STTL >] for about 5 or more seconds to select the audio you wish to record.

On the main unit



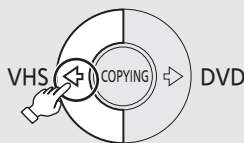

Press and hold for about 3 seconds.



- Check if copying starts properly (“COPY” lights on the unit’s display).
- Copying automatically stops when playback of the disc finishes or the tape reaches its end.

Tips

•When you start copying from the selected title

- 1 Press [DRIVE SELECT] to select the DVD drive.
 - 2 Press [DIRECT NAVIGATOR].
 - 3 Press [, , , >] to select the title you want to start recording, then press [OK].
 - 4 Go to the operation shown above.
- Index signals are automatically recorded on the tape according to the division of titles on the DVD (⇒ 40, VHS Index Search System (VISS)).

•To cancel copying in the middle

Press [].

- You can also press and hold [RETURN >] for about 3 or more seconds to cancel copying in the middle.

Notes

- If you start copying when the resume function is activated, the DVD is copied from the beginning of the title you stopped play at.
To copy a whole disc, press [] to deactivate it before copying (⇒ 20).
- When copying doesn’t start, the “COPYING” indicator on the main unit blinks for about 7 seconds. Check if the unit is properly prepared.
- **-R -R DL -RW(V) +R +R DL**
You cannot copy the content of a finalised disc.
- Titles are copied at normal speed.

To copy from a finalised disc

(⇒ 59, Copying a finalised DVD-R, DVD-R DL, DVD-RW (DVD-Video format), +R and +R DL)

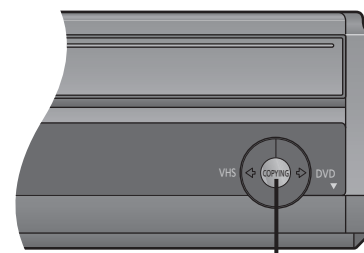

COPYING indicator

Deleting Titles

Preparation:









- Turn on the television and select the appropriate video input to suit the connections to this unit.
- **RAM** If the disc is protected, release protection (⇒ 64).
- Insert the disc containing the programme to be deleted.

Important:

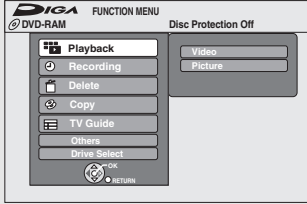
Once deleted, contents cannot be recovered.

DELETE Navigator

RAM -R -R DL -RW(V) +R +R DL +RW

- 1**  to select the DVD drive.
- 2** With the unit stopped  
- 3** ▲, ▼ to select "Delete", then 
- 4** ▲, ▼ to select "Video", then 
- 5** ▲, ▼, ◀, ▶ to select the title, then 
 A check mark is displayed. Repeat this step until you select all necessary items. Press [PAUSE] again to cancel.
- 6** 
- 7** ◀ to select "Delete", then 

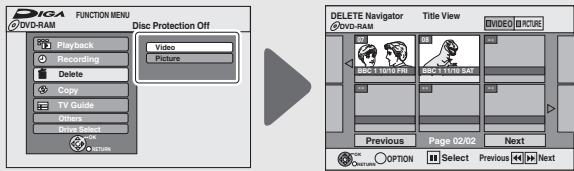

Tips

To return to the previous screen

Press [RETURN ⇨].

To view other pages

Press [▲, ▼, ◀, ▶] to select "Previous" or "Next", then press [OK].

• You can also press [◀◀, ▶▶] to view other pages.

Deleting Titles During Playback

RAM -R -R DL -RW(V) +R +R DL +RW

- 1** During playback 
- 2** ◀ to select "Delete", then 



Notes

- You cannot delete while recording or copying.
- **+R +R DL +RW** Even if you have set protection on other equipment, such titles are deleted.
- **-R -R DL -RW(V) +R +R DL** It is not possible to delete contents from finalised disc.
- **-R -R DL +R +R DL** Available disc space does not increase after deletion.
- **RAM** Deleting an item increases the available disc space by the amount of space taken by the item deleted.
- **-RW(V) +RW** Available disc space increases when you delete the last title.
- **RAM -RW(V) +RW** To recover total disc space, the disc needs to be formatted. (⇒ 64)

Notes for Recording

Selecting audio for recording

Broadcast in multi-channel sound:

You can select audio language when received audio in multi-channel broadcast ("Multi Audio" appears at the bottom of digital channel information display). However, audio cannot be switched after recording.



Select the audio that you want to record in "DVB Multi Audio" in the on-screen display (⇒ 63).

About the aspect when recording a programme

RAM -R -R DL -RW(V) VHS

The original aspect used for the source programme will also be used with the recording. However, in the following case, programme will be recorded in 4:3.

-R -R DL -RW(V)

Programme recorded using "EP" or "FR (recordings 5 hours or longer)" recording modes will be recorded in 4:3 aspect.

+R +R DL +RW

The programme will be recorded in 4:3 aspect.



Copy-once recording

RAM CPRM compatible discs only.
12 cm



-R -R DL -RW(V) +R +R DL +RW



(○: Can do, -: Cannot do)

- Even when copying to video tape the title may not be copied correctly because of the copy guard.
- You cannot copy a playlist created from "One time only recording" titles.

Playing the disc on other DVD players

-R -R DL -RW(V) +R +R DL

The disc must be finalised after recording or copying (⇒ 65).

It is necessary to finalise DVD-R, etc. on this unit after recording or copying titles to them. You can then play them in the same way as a commercially sold DVD-Video. However, the discs become play-only and you can no longer record or copy.*

* You can record and copy again if you format DVD-RW.



Record to DVD-R, etc.



Finalise

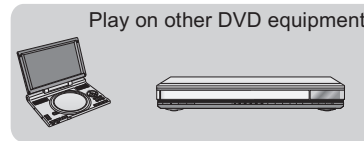

Play on other DVD equipment

+RW

If the disc failed to play on other equipment, we recommend you create top menu (⇒ 65). However, even with Top Menu, +RW may not play on other players.

Recording to DVD-R DL and +R DL

DVD-R DL and +R DL discs have two layers of recording surface on one side.

- It is not possible to record continuously from the first layer to the second layer. Recording stops when space on the first layer becomes full. You must close the first layer to start recording on the second layer (⇒ 65). Closing makes the first layer unavailable for recording (editing is still available). You cannot cancel closing. Make certain before proceeding.

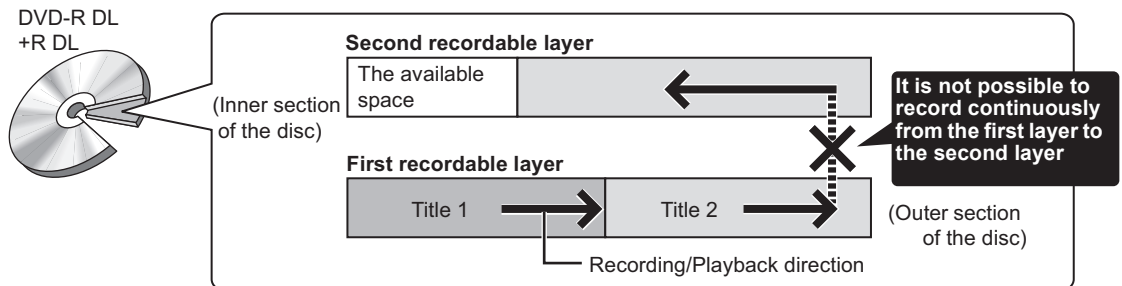

- It is not possible to record to DVD or VHS drive while recording to the other drive.

Advanced Recording

DVD Recording Modes and Durations

Depending on the content being recorded, the recording times may become shorter than indicated.
(The times provided on this table are an estimate.)

Recording Mode	DVD-RAM		DVD-R DVD-RW +R +RW (4.7 GB)	DVD-R DL ^{*3} , +R DL ^{*3} (8.5 GB)	
	Single-sided (4.7 GB)	Double-sided ^{*1} (9.4 GB)		First layer (L0)	Second layer (L1)
XP (High quality)	1 hour	2 hours	1 hour	55 minutes	50 minutes
SP (Standard play)	2 hours	4 hours	2 hours	1 hour 50 minutes	1 hour 40 minutes
LP (Long play)	4 hours	8 hours	4 hours	3 hours 40 minutes	3 hours 20 minutes
EP (Extra long play)	8 (6 ^{*2}) hours	16 (12 ^{*2}) hours	8 (6 ^{*2}) hours	7 hours 25 minutes (5 hours 30 minutes ^{*2})	6 hours 50 minutes (5 hours 15 minutes ^{*2})
FR (Flexible Recording)	8 hours maximum	16 hours maximum	8 hours maximum	7 hours 25 minutes maximum	6 hours 50 minutes maximum

- *1 It is not possible to record or play continuously from one side of a double sided disc to the other.
- *2 When "Recording time in EP mode" has been set to "EP (6 hours)" in the Setup menu (⇒ 68).
The sound quality is better when using "EP (6 hours)" than when using "EP (8 hours)".
- *3 Refer to "Recording to DVD-R DL and +R DL" (⇒ 27).

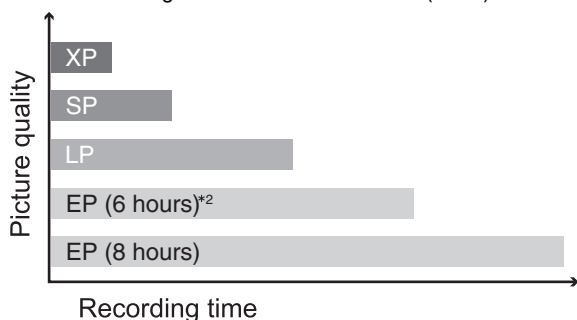

Notes

- This unit uses variable bit rate (VBR) recording which varies the amount of data recorded to suit the picture quality, so actual recording times and remaining recording times shown by the unit will be different. (R DL +R DL) The difference will be especially noticeable.) Use a disc with enough remaining blank space.
- When recording to DVD-RAM using EP (8 hours) mode, play may not be possible on DVD players, even if they are compatible with DVD-RAM. In this case use EP (6 hours) mode.

Tips

- Maximum number of titles to a disc
RAM -R -R DL -RW(V) 99 titles on a disc
+R +R DL +RW 49 titles on a disc
- FR (Flexible recording mode)**
Using "Flexible Recording" is convenient in these kinds of situations:
 - When the amount of free space on the disc makes selecting an appropriate recording mode difficult
 - When you want to record a long programme with the best picture quality possible

e.g., Recording a 90-minute programme to 4.7 GB DVD-RAM disc:
- If you select XP mode, the programme will not fit on one disc.



A second disc is necessary for 30 minutes of the programme.

- If you select SP mode, the programme will fit on one disc.



However there will be 30 minutes remaining disc space.

- If you select "Flexible Recording" the programme will fit on one disc perfectly.



You can set FR mode when programming timer recordings and flexible recording (⇒ 30).

VHS Recording Modes and Durations

Recording Mode	Durations
SP	You can record the length shown on the tape. ● If the image quality is important to you or if you wish to store the tape for a long period, select this mode.
LP	2 times the length of SP mode. ● LP cannot be selected when recording NTSC signals. ● The unit can play tapes recorded in LP mode on other equipment.
EP	3 times the length of SP mode.
AUTO	Automatically switches the recording mode to LP (NTSC to EP) mode during a timer recording if there is not enough tape left to record the programme in SP mode.

Tips

- To prevent recording errors:**
Set a timer recording period slightly longer than the actual programme (to make sure the programme is recorded in full).

- AUTO Mode**
Timer Recording

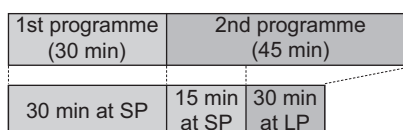

Video tape
(e.g.: 60-minute cassette)

- The tape length must be set correctly (⇒ 71).
- Picture distortion may occur when the recording mode switches.
- This may not work correctly with some video cassettes.
- It may not work correctly when "NTSC" is set as the "TV System" (⇒ 70).

When the format confirmation screen is displayed

Formatting is the process of making media such as DVD-RAM recordable on recording equipment.

Important:

Formatting permanently deletes all disc contents (including the contents that have been recorded on a PC), regardless of protection status of disc.

RAM -RW(V) +R +R DL +RW

The following screen may appear when inserting a new disc or a disc that has been recorded on another equipment.

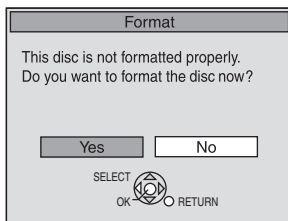

Only format the disc if you intend to use it for recording.

Do not format if you intend to view pre-recorded titles or contents from the disc.

◀ to select "Yes", then

Tips

Refer to "Formatting Discs" (⇒ 64) for more detail of formatting.

When removing a Recorded or Copied Disc

-R -R DL -RW(V) +R +R DL

After recording or copying, if you press [▲ OPEN/CLOSE] to eject the disc, the following screen may appear.

e.g. Disc recorded with Videos

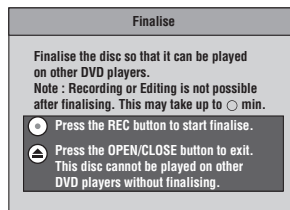

Finalising

DVD-R, etc. recorded or copied on this unit cannot be played on other players immediately after recording or copying. Using the Finalise feature allows you to play these discs on other players. Once the disc is finalised you will no longer be able to record onto the disc.

[However if you format the DVD-RW, you can record and copy onto the disc again. (⇒ 64)]

to start finalising.
or
 to eject the disc without finalising.

Notes

- You cannot stop finalising once you have started it.

Tips

- If you want to provide the disc with a name or set play menu select, select "Disc Name" or "Auto-Play Select" in "DVD Management" before finalising. (⇒ 64)
- Refer to "Finalising" (⇒ 65) for more detail of finalising.

Specifying the Recording Time —One Touch Recording

RAM -R -R DL -RW(V) +R +R DL +RW VHS

This function allows specifying the length of recording time up to 4 hours.

During recording
On the main unit only

repeatedly until the desired time is reached.

– The recording time and the unit's display changes as follows:

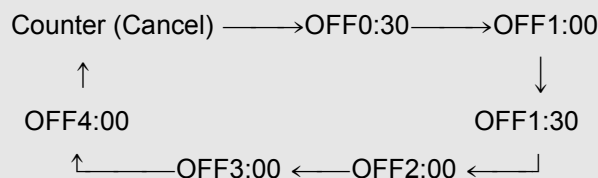

Notes

- This function does not work during timer recording or Flexible Recording.
- Recording stops and the set time is cleared if you press [■].
- This unit is turned to standby mode when this unit is not operated for approximately 5 minutes after completing One Touch Recording, if "Auto Standby after OTR" is set to "On" in the Setup menu. (Default setting: "On") (⇒ 72)

Direct TV Recording

RAM -R -R DL -RW(V) +R +R DL +RW

This function allows you to immediately start recording the programme that you are viewing on the TV without having to change the channels on this unit.

You can use the function when you connect the unit to a Q Link compatible TV using a 21-pin Scart cable.

You can also use this function using VIERA Link. (⇒ 46)

Press and hold for about 1 second.

Tips

To stop recording
Press [■].

Notes

- When Digital Teletext (⇒ 48) is displayed, Direct TV recording is unavailable.
- If you switch TV channels while using Direct TV recording, the Direct TV recording stops.
- When "EXT-L" lights on the unit's display (⇒ 31), Direct TV recording is unavailable.

Advanced Recording

Flexible Recording

RAM -R -R DL -RW(V) +R +R DL +RW

The unit sets the best possible picture quality that fits the programme within the remaining disc space. The recording mode becomes FR mode. Refer to “FR (Flexible recording mode)” (⇒ 28).

Preparation:

- Select the channel or the external input to record.
- Press [DRIVE SELECT] to select the DVD drive.

1 With the unit stopped



2 ▲, ▼ to select “Others”, then

3 ▲, ▼ to select “Flexible Rec”, then



4 ◀, ▶ to select “hour” and “min.” and ▲, ▼ to set the recording time.

- You can set “hour” and “min.” using the numbered buttons.

5 When you want to start recording ▲, ▼, ◀, ▶ to select “Start”, then



- Recording starts.

Notes

- You cannot record more than 8 hours.

Tips

To exit the screen

Press [EXIT].

To stop recording partway

Press [■].

To show the remaining recording time

Press [STATUS ⓘ] to show the remaining recording time.

e.g., DVD-RAM

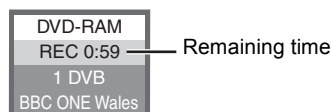

Playing while you are recording

Chasing Playback

RAM

Allows playback from the beginning of the title you are recording.

During recording



Tips

To stop play

Press [■] once.

To stop recording

2 seconds after play stops, press [■].

To stop timer recording

2 seconds after play stops,

- 1 Press [■].
- 2 Press [◀, ▶] to select “Stop Recording”, then press [OK].

Simultaneous Record and Playback

RAM VHS

Allows playback of a previous title, while recording something else.

- You can play DVD or VHS while recording to the other drive. The recording will not be affected.
 - DVD playback (⇒ 20, 38, 39)
 - VHS playback (⇒ 21, 40, 41)

Notes

VHS cannot be output via “DVD priority out” while recording on DVD (⇒ 75). You can watch the VHS playback by connecting 21-pin Scart cable from AV1 on the unit to the television.

Preparation:

- Select the appropriate AV input of the television.
- Press [DRIVE SELECT] to select the drive.

RAM

1 During recording



2 ▲, ▼, ◀, ▶ to select the title to play, then

VHS

During recording



Tips

To stop play

Press [■].

To exit the DIRECT NAVIGATOR screen

Press [DIRECT NAVIGATOR].

To stop recording

After play stops

- 1 **RAM** Press [DIRECT NAVIGATOR] to exit the screen.
- 2 Press [■].
- 3 If the recording stop confirmation screen is displayed, press [◀, ▶] to select “Yes” or “Stop Recording” and press [OK] to stop recording.

Notes

- During playing while you are recording, you cannot edit or delete titles.



Recording from a Digital Satellite Receiver

RAM -R -R DL -RW(V) +R +R DL +RW VHS

Manual Recording

Preparation:

- **RAM** If the disc is protected, release protection (⇒ 64).
- **VHS** Ensure accidental erasure tab is intact.
- Connect a digital satellite receiver to this unit's AV2 input terminals (⇒ 11).
- Set the "AV2 Input" to match the connected equipment in the Setup menu (⇒ 71).
- When the output signal from the external equipment is NTSC, change the "TV System" to "NTSC" in the Setup menu (⇒ 70).

- 1 With the unit stopped
 to select "AV2" for the digital satellite receiver you have connected.
- 2
 to select the DVD or VHS drive.
 – Insert a disc or video cassette with enough remaining blank space (⇒ 7).
- 3
 to select the recording mode.
- 4 Select the channel on the digital satellite receiver.
- 5
 to start recording.

Tips

To skip unwanted parts

Press [II] to pause recording. (Press again to restart recording.)

- **VHS** When recording is paused for 5 minutes or more, the unit returns to stop.

To stop recording

Press [■].

Notes



- This unit cannot record NTSC signals to discs that already have PAL signal recordings.

Linked timer recordings with external equipment (SKY Digital STB/digital satellite receiver) — EXT LINK

To record programmes from a SKY Digital STB/digital satellite receiver using timer programming

Preparation:

- **RAM** If the disc is protected, release protection (⇒ 64).
- **VHS** Ensure accidental erasure tab is intact.
- Make sure you connect the AV2 terminal of this unit to "VCR Scart Terminal" of a SKY Digital STB/digital satellite receiver with a 21-pin scart cable (⇒ 11).
- Set the "AV2 Input" and "Ext Link" to match the connected equipment in the Setup menu (⇒ 71).

- 1 Make timer programming on SKY Digital STB/digital satellite receiver.
 – Refer to the equipment's operating instructions.
- 2
 to select the DVD or VHS drive.
 – Insert a disc or video cassette with enough remaining blank space (⇒ 7).
- 3
 to start recording.
 – The unit turns off and "EXT-L" lights on the unit's display to indicate timer recording standby has been activated.
 – While the unit is in EXT LINK standby mode or recording, most operations on this unit are prohibited ([▲ OPEN/CLOSE], [⏻/I] etc.).

Tips

To cancel the external control

Press [EXT LINK] to stop recording or to cancel linked timer recording standby (The unit turns on and "EXT-L" disappears.).

Manual timer recordings (⇒ 33)

Notes

- In order to prevent accidental operation, press [EXT LINK] to cancel the setting after recording is finished.
- This function does not work when "TV System" is set to "NTSC" in the Setup menu (⇒ 70).
- This function does not work with some equipment. Refer to the equipment's operating instructions.
- The beginnings of recordings may not be recorded correctly in some cases.
- When "Ext Link" is set to "Ext Link 2", this function does not work if the input signal is NTSC system.
- Programmes are recorded as one title on this unit when the end time of the earlier timer recording and the start time of the later timer recording are close to each other.
- **RAM** To divide the titles, go to "Divide Title" (⇒ 51).
- When this unit is in EXT LINK standby ("EXT-L" is shown on the unit's display), the TV Guide data cannot be downloaded.
- While the unit is in EXT LINK standby mode or recording, AV1 output terminal outputs the signal which is input from the AV2 input terminal irrespective of "AV1 Output" setting (⇒ 71).
- (Except for **VHS**) During EXT LINK standby mode or recording, playback is only available if you select the DVD drive in the step 2 above.
- When "EXT-L" lights on the unit's display, Direct TV Recording is unavailable.

Recording from an External Device

RAM -R -R DL -RW(V) +R +R DL +RW VHS

- Turn off the unit and other video equipment before connecting.
- Refer to "Adding a VCR: Connecting to a Television and a Video Cassette Recorder" when connecting to the AV2 input terminals on the rear panel. (⇒ 75)

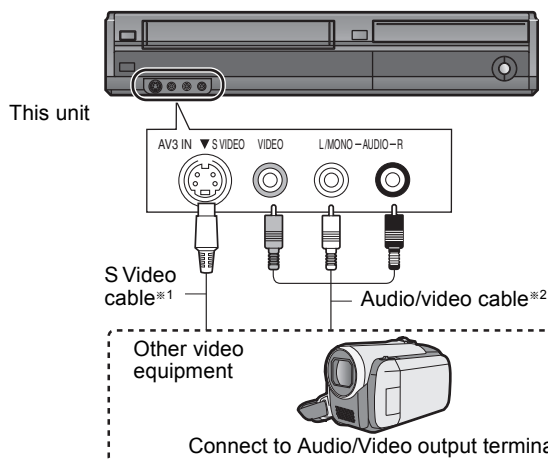

*1 You can get a sharper, clearer picture by connecting with an S Video cable instead of the yellow video cable.

*2 Connect to terminals of the same colour.

- If the audio output of the external device is monaural, connect to L/MONO on the AV3 input terminals at the front.

Preparation:

- Turn on the unit.
- **RAM** If the disc is protected, release protection (⇒ 64).
- **VHS** Ensure accidental erasure tab is intact.
- When the output signal from the external device is NTSC, change the "TV System" to "NTSC" in the Setup menu (⇒ 70).
This unit cannot record NTSC signals to discs that already have PAL signal recordings.
- To reduce noise in input from an external device, set "Copy NR" to "On" in the on-screen display (⇒ 63).

- 1** **DRIVE SELECT** to select the DVD or VHS drive.
– Insert a disc or video cassette with enough remaining blank space (⇒ 7).
- 2** **REC MODE** to select the recording mode (⇒ 28).
- 3** **INPUT SELECT** to select the input where your external device is connected.
– Front panel inputs are AV3.

Recording to DVD

RAM -R -R DL -RW(V) +R +R DL +RW

Perform steps **1** - **3** (⇒ left).

- 4** Start play on the external device.
- 5** **REC** at the point you want to start recording to the disc.

Recording to VHS

VHS

Perform steps **1** - **3** (⇒ left).

- 4** **PLAY** to bring the tape to the point at which you want to start recording from.
- 5** **PAUSE** when you reach that point.
- 6** **REC** to put the unit in recording standby.
- 7** Start play on the external device.
- 8** **PAUSE** to start recording at the point you desire.

Tips

To skip unwanted parts

Press **[II]** to pause recording. (Press again to restart recording.)

To stop recording

Press **[■]**.

RAM -R -R DL -RW(V) +R +R DL +RW

- Using Flexible Recording (⇒ 30), you can record the content of a video cassette (approx. 1–8 hours) to a 4.7 GB disc with the best possible quality of recording without wasting disc space.

Notes

- When timer recording starts while recording from an external device, timer recording takes priority and recording from the external device stops.
- If video is copied from another piece of equipment to this unit, then the video quality will be degraded.
- Almost all videos and DVD-Video on sale have been treated to prevent illegal copying. Any software that has been so treated cannot be recorded using this unit.

Advanced Timer Recording

RAM -R -R DL -RW(V) +R +R DL +RW VHS

Manual timer recordings

Preparation:

- Turn on the television and select the appropriate video input to suit the connections to this unit.
- **RAM** If the disc is protected, release protection (⇒ 64).
- **VHS** Ensure accidental erasure tab is intact.
- Insert a disc or a video cassette with enough remaining blank space.
- Confirm that the clock on the unit's display is set to the correct time.
- If connected via a digital satellite receiver, please ensure before a timer recording starts the required channel is set on the digital satellite receiver.

1 PROG/CHECK



2 ▲, ▼ to select "New Timer Programme", then

- If "New Timer Programme" is already selected, press [OK].

3 ◀, ▶ to move through the items and ▲, ▼ to set the items.

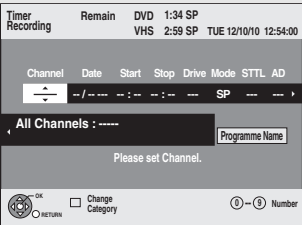

Channel:

- TV Station Name/External Input
 - When recording digital satellite programmes, select "AV2".
 - You can press the "Blue" button to change the category. [e.g., Free Channels, Radio, Registered Favourites (⇒ 66, Favourites Edit)]

Date:

- You can set a daily or weekly programme (⇒ right, Tips).

Start (start time)/Stop (end time):

- Hold button to change in 30-minute increments or decrements.

Drive:

- DVD or VHS

Mode:

- Recording mode (⇒ 28)

STTL [Subtitles (⇒ 48)]*1, *2:

- AUTO/OFF

AD [Audio Description (⇒ 48)]*1, *3:

- AUTO/OFF

Programme Name:

- Press [OK] (⇒ 49, Entering Text).

*1 If "AUTO" is selected, and if the programme includes the information of subtitles or Audio Description, they are automatically recorded with the programme.
 *2 When there are multiple languages, select the subtitle language (⇒ 67, DVB Preferred Subtitles)
 *3 You can switch the Audio Description and change its volume during timer recording.

4

- The timer icon is displayed in the left column.



- "⌚" lights on the unit's display to indicate timer recording standby has been activated.
- Repeat steps **2-4** to programme other recordings.
- Press [⏻] to turn the unit off.

Notes

- "⌚" on the unit's display flashes when the unit cannot go to timer recording standby.
- If two timer recording times overlap, the first recording always has priority. The second recording will start only after the first recording has finished.
- Recorded subtitles cannot be deleted later.
- A timer recording will not start while a disc is being formatted, deleted or finalised. The recording begins afterwards.
- When "Channel" is set in "AV1", "AV2" or "AV3", "STTL" and "AD" setting is unavailable.
- Recorded Audio Description cannot be deleted.

Tips

To exit the timer recording list

Press [PROG/CHECK].

"Date" Setting

Each press of [▲] changes items in the order below.
 (Each press of [▼] changes items in the reverse order.)

Current date → ---- → One month later

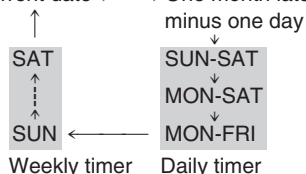

- You can also use the numbered buttons to enter "Channel", "Date", "Start" and "Stop".
- You can also press [DRIVE SELECT] to switch the drive, [REC MODE] to switch "Mode" and press [STTL] to switch "STTL".

Language for broadcast with multi-audio or multi-subtitle

In timer recording of broadcast with multi-audio or multi-subtitle, audio and subtitle language to be recorded will follow the setting of "DVB Preferred Multi Audio" and "DVB Preferred Subtitles" in the Setup menu (⇒ 67)

To cancel a timer recording in progress

Preparation:

- Turn on the television and select the appropriate video input to suit the connections to this unit.

1 While the unit is on

- Confirmation screen appears.

2 ◀ to select "Stop Recording", then

Notes

- Recording stops and the timer programme is deleted. (Daily and weekly timer programmes remain and timer recording will start from the next time the timer recording is set.)

Advanced Timer Recording

If the "Overlapped Timer Recording" screen appears

If you set a timer recording that will overlap with other timer recordings using the GUIDE Plus+ system, the "Overlapped Timer Recording" screen appears to help you eliminate the overlapping. Follow the on-screen instructions.





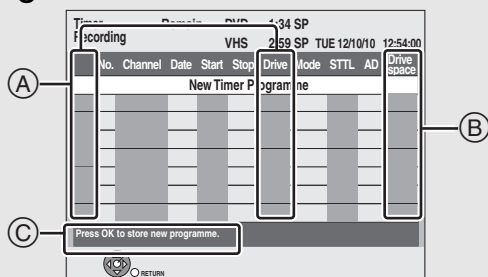

Check, Change, Delete Programmes, or Resolve Overlapping

The timer recording list can be viewed even when the unit is off.

1  then **▲**, **▼** to select the programme.



A Timer Recording screen icons

- : Timer programme is active.
 - : Currently recording
 - : Programmes are overlapped. Recording of the programme with the later start time starts when the earlier programme finishes recording.
 - : You stopped a daily or weekly timer recording. The icon disappears the next time the timer recording starts recording.
 - : The disc was full. (not enough space)
 - : The TV programme may not be recorded due to copy-protect.
 - : Recording stopped (Dirty disc or video cassette, etc.)
- Drive** Recording drive is set to DVD or VHS

B Drive space (Except for VHS)

When the drive is set to VHS, "-" is displayed.

OK: Recordable



→ **(Date):** For daily or weekly timer recordings, the display will show until when recordings can be made (up to one month ahead from the present time) based on the time remaining on the disc.

- !:** It may not be possible to record because:
- the disc is write-protected.
 - there is no more space left.
 - the number of possible titles has reached its maximum.
 - programmes are overlapped.
 - the timer programme is deactivated.

C Channel name, programme name and other information are displayed.

2a  to delete.

- You cannot delete programmes that are currently recording.

2b  to modify the programme.
▲, **▼**, **◀**, **▶** to make changes, then 

2c When a programme with  is selected

- If the programme was set from the TV Guide, the available repeat programmes are displayed. Press **▲**, **▼** to select, then press **[OK]**.
- If the on-screen instructions do not appear, change or delete the overlapped programme.

Tips

- You can enter up to 16 programmes a month in advance.

You can also delete a programme with the following steps.

- 1 Press **▲**, **▼** to select the programme and press **[OPTION]**.
- 2 Press **▲**, **▼** to select "Delete" and press **[OK]**.

To exit the timer recording list

Press **[PROG/CHECK]**.

Notes

- Recording may fail if there are changes to the station's programming.
- "☉" disappears from the unit's display when no timer programme is set or when all timer programmes are deactivated.
- The "Guide Link" function may not work if you manually change the start/end time by over 10 minutes.
- Programmes that failed to record are deleted from the timer recording list at 4 a.m. two days later.

To deactivate timer programme (e.g. to interrupt a daily or weekly timer programming)

After performing step **1** (⇒ left)

2  (Red)
- "☉" (⇒ left) disappears from the timer recording list.
- Press the "Red" button again to activate timer programme.

Tips

You can deactivate the timer programme in the following procedure as well.

Perform step **1** (⇒ left)

- 1 Press **[OPTION]**
- 2 Press **▲**, **▼** to select "Timer Off", then press **[OK]**.

Making timer recordings on the television

RAM **-R** **-R DL** **-RW(V)** **+R** **+R DL** **+RW**

To make a timer recording with your television, connect to a television with a Q Link function (⇒ 46) that you can use for setting timer recordings using a fully wired 21-pin Scart cable (⇒ 10,11).

1 Make timer programming on the TV.

2  to turn the unit off.

– The start and end of recording is controlled by TV.

Tips

To stop recording

Press [■].

Notes

- When this unit is in EXT LINK standby (“EXT-L” on the unit’s display lights), recording from TV does not start.
- Programmes are recorded as one title on this unit when the end time of the earlier timer recording and the start time of the later timer recording are close to each other.

RAM To divide the titles, go to “Divide Title” (⇒ 51).

Notes on timer recording

- When a timer recording is set, DVDs that were recorded using a different TV system (PAL/NTSC) cannot be played unless the TV system is changed in the Setup menu (⇒ 70) or the timer recording has completed or has been cancelled.
- Timer recordings are activated regardless of whether the unit is turned on/off.
- Timer recordings begin when the set time is reached even when playing.
- Timer recordings do not begin while editing or copying.
- If the unit is turned on when timer recording begins, it remains turned on after recording finishes. It does not turn off automatically. You can turn the unit off during timer recording.
- When you programme successive timer recordings to start immediately one after the other, the unit cannot record the part at the beginning of the later programmes.

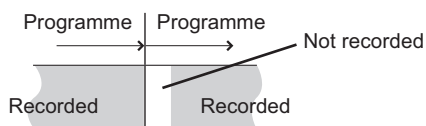

- The “Overlapped Timer Recording” screen may be displayed immediately after you turn on this unit, if new overlapping occurred. Refer to “Check, Change, Delete Programmes, or Resolve Overlapping” (⇒ 34).

GUIDE Plus+ system

What is the GUIDE Plus+ system?

The GUIDE Plus+ system gives you an overview of digital television and radio programmes up to 7 days in advance. For many of these programmes, you can select additional information provided by the stations. You can search the programme preview according to various topics such as sport, films etc., according to categories such as TV or radio. Also, you can search for programmes using programme information such as programme names etc. You can easily find the desired programmes and set Timer recording.

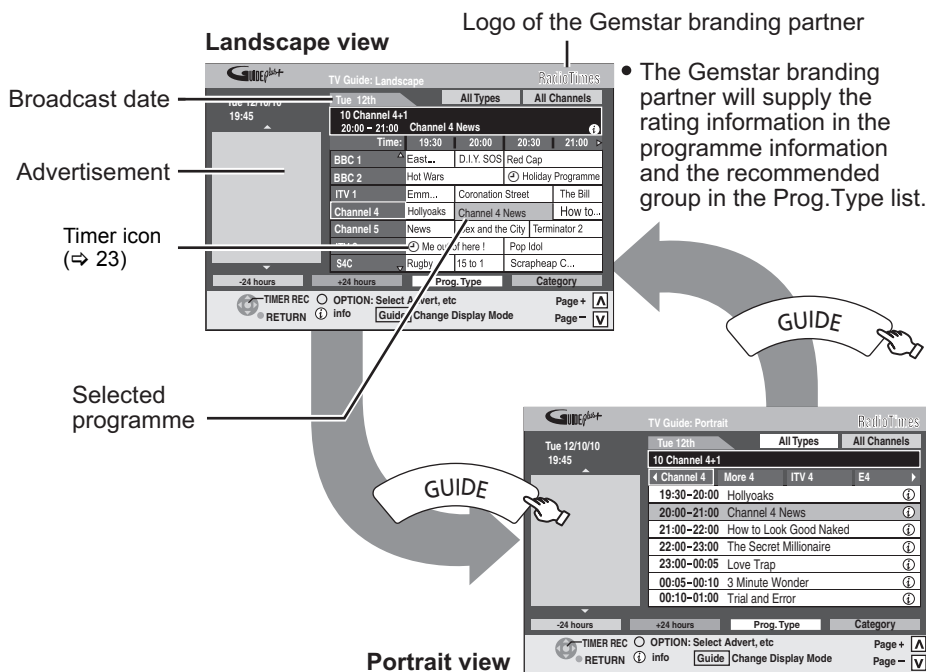

Landscape view:

The GUIDE Plus+ system offers detailed information as if you see a TV programme magazine. This is convenient to check the status of Timer recording.

Portrait view:

This is convenient to narrow down channels to search for the programme you want to watch.

To switch between Landscape view and Portrait view
Press [GUIDE].

Using the GUIDE Plus+ list

To change channels	<p>Landscape view Press [▲, ▼] to select a channel.</p> <p>Portrait view Press [◀, ▶] to select a channel. The GUIDE Plus+ list appears for this channel.</p>
To view a programme list for another day	<ul style="list-style-type: none"> • Jump ahead 24 hours Press the "Green" button to jump ahead by one day. • Jump back 24 hours Press the "Red" button. You can only jump back to the current date. Past information cannot be viewed.
To change the page of the GUIDE Plus+ list	Press [^ v CH].
To see programme information (programme name, programme duration, broadcast time, description, etc.) (Programmes with the ⓘ symbol)	<p>Press [STATUS ⓘ].</p> <ul style="list-style-type: none"> • Press [▲] and [▼] to scroll up and down. <p>To show other pages Press [CH ^] (Previous) or [v CH] (Next).</p> <p>To return to the GUIDE Plus+ list Press [STATUS ⓘ].</p>
To return to the previous screen	Press [RETURN ↵].
To exit the screen	Press [EXIT].

Notes

- The receipt of the GUIDE Plus+ system data is only possible via the aerial input of this unit. The receipt of the GUIDE Plus+ data via externally connected digital satellite receivers is not possible.
- The GUIDE Plus+ system setup will not work if the clock is not set correctly or the wrong postcode is selected.

View advertisement

Enter your postcode when using this function for the first time (⇒ 73, Post Code) and leave the unit in standby over night to capture the information.

If you have already entered your postcode in Owner ID (⇒ 13), you do not have to enter again.

If you enter an incorrect postcode for your area, or no postcodes are entered, advertisement may not be displayed correctly.

To display advertisement information

- 1 Press [OPTION].*
- 2 Press [▲, ▼] to select "Select Advert", then press [OK].

* While the advertisement information is not captured, "Enter Words" screen is displayed. (⇒ 37, Searching desired programmes on GUIDE Plus+ list by words)

- To display the latest advertisement, you will need to update the information.
- To update the information continuously, this unit must be left in standby mode over night.

To change advertisements

Press [▲, ▼].

To return to TV Guide

Press [RETURN ↵].

Notes

- Some advertisements are for future programmes and you can set the timer recording of the programmes using the advertisement screen. Follow the on-screen instructions.
- The information from the GUIDE Plus+ system will not be lost even if the unit is turned off at the mains outlet.

Tips

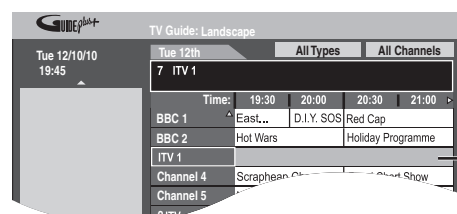

When the unit displays "No Data" or the empty GUIDE Plus+ list:





- Some digital broadcast may not send programme information. Set the timer recording manually (⇒ 33, Manual timer recordings).

Selecting the programme from the desired programme type or category

This function lets you display a GUIDE Plus+ list sorted by programme type (e.g. Movie, Sport) or category (e.g. Free Channels, Radio).

- 1** 
 - The GUIDE Plus+ list appears.
- 2a**  (Yellow) to display the list of programme type.

Type	Category
All Types	All Channels
All Types	All Channels
Movie	Free Channels
News	Radio
Entertainment	Data
Sport	Favourite 1
Children's	Favourite 2
Education	Favourite 3
Lifestyle	Favourite 4
Drama	
- 2b**  (Blue) to display the list of categories.
- 3** ▲, ▼ to select the desired item.
- 4** 
 - A list appears with all programmes of the selected item.
 - When you select the landscape view, the programmes that belong to the selected programme type are highlighted.

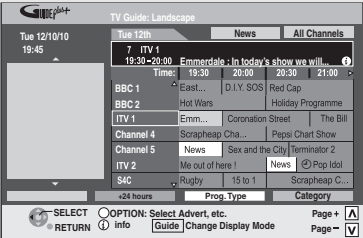

e. g., Programme type, "News" is selected in step 3 of Landscape view.





- 5** ▲, ▼, ◀, ▶ to select the programme.

After searching ⇒ right, Tips in "Searching desired programmes on GUIDE Plus+ list by words"

Searching desired programmes on GUIDE Plus+ list by words

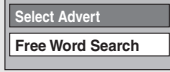
By entering words, you can search for programmes from the GUIDE Plus+ list using the programme information.

- 1** 
 - The GUIDE Plus+ list appears.
- 2** 

- 3** ▲, ▼ to select "Free Word Search", then 
- 4** Enter the word you would like to search for, then 

Entry method ⇒ 49, Entering Text
- 5** ▲, ▼ to select "Simplified Search" or "Detailed Search", then 

Simplified Search:
It searches the programme names only.

Detailed Search:
It searches all the information on the programmes. It might take more time to search the desired programme.

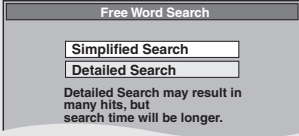
- 6** ▲, ▼, ◀, ▶ to select the programme.

After searching ⇒ below, Tips

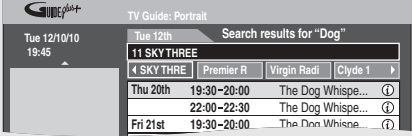

Search results appear.

Notes

- The broadcasters allocate individual programmes to topic areas. This function does not work properly unless the information which distinguishes the programme type and categories sent from broadcast stations is correct.
- The programme list is available immediately if this unit has found a digital station and loaded the information in the memory. This process can take a while depending on the particular station.
- The programme list data are continuously downloaded in the background when the unit is turned on. That means that the programme list can sometimes change while you are looking at it.

Tips

To return to the previous GUIDE Plus+ list before you have selected the programme type or categories
Select "All Types" of the programme type and "All Channels" of the categories in step 3 (⇒ above).

To return to the previous screen

Press [RETURN ↵].

To exit the screen

Press [EXIT].

Tips

After searching

- ① Press [OK].
- ② If "Timer Recording" screen appears
Go to step 3 of "Timer Recording" (⇒ 23)
If "Selection Screen" appears
Press [▲, ▼] to select the item.
 - "View" ⇒ 19, Watching Television
 - "Rec." ⇒ 23, Timer Recording, step 3
 - "Delete" ⇒ Timer recordings can be cancelled.
Press [◀, ▶] to select "Yes" and press [OK].
– The timer icon disappears.

To return to the previous screen

Press [RETURN ↵].
It may return to the GUIDE Plus+ screen.

To exit the screen

Press [EXIT].

Advanced Disc Playback

Selecting Titles to Play

You can easily select and play recorded programmes by using DIRECT NAVIGATOR.

RAM -R -R DL -RW(V) +R +R DL +RW -RW(VR)

1

RAM
When "VIDEO" is not selected, press the "Red" button to select "VIDEO".

2 ▲, ▼, ◀, ▶ to select the title you want to watch, then

Tips

To select the title with the numbered buttons

e.g., 5: [0] ⇒ [5] 15: [1] ⇒ [5]

To view other pages

Press [▲, ▼, ◀, ▶] to select "Previous" or "Next", then press [OK].
– You can also press [◀◀, ▶▶] to view other pages.

To exit the DIRECT NAVIGATOR screen

Press [DIRECT NAVIGATOR].

DIRECT NAVIGATOR screen icons

- Protected.
- Not recorded due to recording protection (Digital broadcasts, etc.)
- It cannot be played because data is damaged, etc.
- Currently recording.
- "One time only recording" restriction (⇒ 92, CPRM)
- (NTSC) Title recorded using a different encoding system from that of the TV System currently selected on the unit.
- (PAL) •Alter the "TV System" setting on this unit to suit (⇒ 70).

Search

During playback OR

- There are 5 search speeds. Each press increases the search speed. (+R +R DL +RW up to 3 speeds)
- Press [▶] (PLAY) to restart normal playback.

Tips

Depending on the disc, search may not be possible.

Skip

You can skip to the beginning (or the end) of Title/Chapter. Skip is operated for each chapter.

During playback or while paused OR

- Each press increases the number of skips.

Quick View (Play × 1.3)

RAM

Allows you to increase the play speed slightly without distorting the audio.

During playback (Press and hold.)

- Press again to return to normal speed.

Direct Play

During playback, you can access specific titles or scenes through direct entry of the numbered buttons.



•MP3



e.g.,
5: [0] ⇒ [0] ⇒ [0] ⇒ [5]
15: [0] ⇒ [0] ⇒ [1] ⇒ [5]

•Other discs

Input a 2-digit number
e.g.,
5: [0] ⇒ [5]
15: [1] ⇒ [5]

Slow-motion Play

RAM **-R** **-R DL** **-RW(V)** **+R** **+R DL** **+RW**
DVD-V **-RW(VR)** **VCD**

While paused  OR 

- There are 5 slow-motion speeds. Each press increases the speed.
- Press  (PLAY) to restart normal playback.

Notes

- If continued for approx. 5 minutes, slow-motion play pauses automatically (except **DVD-V** **VCD**).
- **VCD** allow slow-motion in the forward direction only.

Frame-by-Frame Viewing

RAM **-R** **-R DL** **-RW(V)** **+R** **+R DL** **+RW**
DVD-V **-RW(VR)** **VCD**

While paused

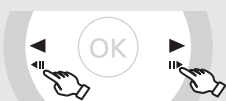

- Each press shows the next or previous frame.
- Press and hold to advance or reverse frame-by-frame in succession.
- Press  (PLAY) to restart normal playback.

Notes

- **VCD** allow Frame-by-Frame in the forward direction only.

Time Slip

RAM
-R **-R DL** **-RW(V)** **+R** **+R DL** (This function does not work with finalised discs.)
+RW **-RW(VR)**

Use to skip in 1-minute or 10-minute increments.

1 During playback 

2 ▲, ▼ to select the time, then 

- Each time you press [▲, ▼], the time increases [▲] or decreases [▼] by 1-minute intervals.
- Press and hold for 10-minute intervals.

Manual Skip

RAM
-R **-R DL** **-RW(V)** **+R** **+R DL** (This function does not work with finalised discs.)
+RW **-RW(VR)**



































































































1-minute skip function:
 Skips approx. 1 minute forward with each press.

During playback 

10-second skip back function:
 Each time you press, play skips backward approximately 10 seconds.

During playback 

Create Chapters

RAM
 After creating chapters in your favourite scenes, you can easily reach the head of scene using [, , , , , , , , , , , , , , , , , , , , , , , , , , , , , , , , , , , , , , , , , , , , , , , , , , , , , , , , , , , , , , , , , , , , , , , , , , , , , , , , , , , , , , , , , , , , , , , , , ] (SKIP) or play on Chapter View. (⇒ 52)

During playback 



Tips

- Chapters cannot be created during EXT LINK standby (⇒ 31).

Advanced Video Cassette Playback



Fast-forward/Rewind

While stopped

-  to fast-forward the tape.
-  to rewind the tape.

Slow-motion Play

During playback

-  Press and hold for about 2 seconds.
- Press  (PLAY) to restart normal playback.



Notes

Slow-motion Play is automatically cancelled after 10 minutes.

Cue/Review

You can quickly review a portion of the video just played or cue to later portions of the tape.

During playback



-  to cue to later portions of the tape.
-  to review a portion just played.
- Press  (PLAY) to restart normal playback.

Notes

Cue/review is automatically cancelled after 10 minutes.

Tips



For quicker operation

- Hold [ , ] to start cue/review and release the button to restart normal playback.

Jet Search

You can high speed search a video in the forward or the reverse direction.

During playback

-  twice to Jet Search forward.
-  twice to Jet Search in reverse.
- Press  (PLAY) to restart normal playback.

Notes

- Depending on your TV, the picture may not be in colour or may be distorted.
- Jet Search is automatically cancelled after 10 minutes.

Jet Rewind

Video tapes will rewind to the beginning of the tape at higher-speed.

During playback or while stopped





Notes

- Depending on the tape or an operating condition, the rewind speed may change somewhat.
- The tape counter is reset to "0:00.00" when the tape is rewound to the beginning.
- Depending on the tape, this function may not work.

VHS Index Search System (VISS)

The unit automatically records special index signals on a tape every time a recording is started (via  REC], or a timer recording). The index search function makes use of these index signals to help you find the beginning of a desired programme quickly and easily.

While stopped or during normal play

-  OR 
- The unit automatically starts playback after the index signal is found.
- Each press increases the number of skips.
- Press  to cancel the search.

Notes

- Up to 20 index signals can be searched in either direction.
- If you overshoot in either direction, press the opposite button to correct.
- For correct operation, make recordings of at least 5 minutes to ensure that index signals are not spaced too closely together.

S-VHS Quasi Playback (SQPB)



This unit can play tapes recorded in S-VHS.

- Some picture noise may occur depending on the type of tape used.
- It is not possible to fully obtain the high resolution S-VHS is capable of.
- This unit cannot record in S-VHS.

Repeat Playback

When the tape reaches the end of the programme, it will automatically rewind to the beginning of the tape and play again.

During playback or while stopped

-  Press and hold for about 5 or more seconds.
- Repeat Playback goes on indefinitely until you cancel it.
- The "R  " indication appears on screen.
- Press  to stop play.

Notes

Only works if there is at least 5 seconds blank space at the end of the programme.

Adjusting the Playback Picture

Manual Tracking

The unit usually makes tracking adjustments automatically, but you may need to do it manually if noise appears on a tape recorded on other equipment.

During playback

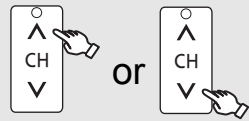

Press and hold until the picture noise disappears.

To return to auto tracking:

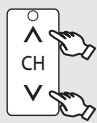

(simultaneously).

Tips

To remove the noise from a paused picture:
Start slow-motion (⇒ 40), then adjust the tracking.

Notes

- This function may not work with some tapes.
- You can also adjust the tracking with [CH ^ v] on the main unit.

Vertical Locking Adjustment

Adjust the vertical synchronisation to stop the picture from shaking while paused.

While paused

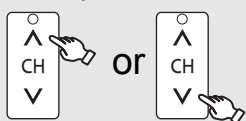

Press and hold until the shaking stops.

To return to the standard position:

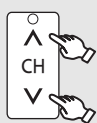

(simultaneously).

Notes

- This function may not work with some tapes.
- You can also adjust vertical synchronisation with [CH ^ v] on the main unit.

Changing Audio during Playback



Press and hold for about 5 or more seconds.

The audio changes as follows.

L R (Stereo) → L → R
 ↑ No display (Normal audio track) ↓

On-screen Display Indicators

to display on-screen indicators.

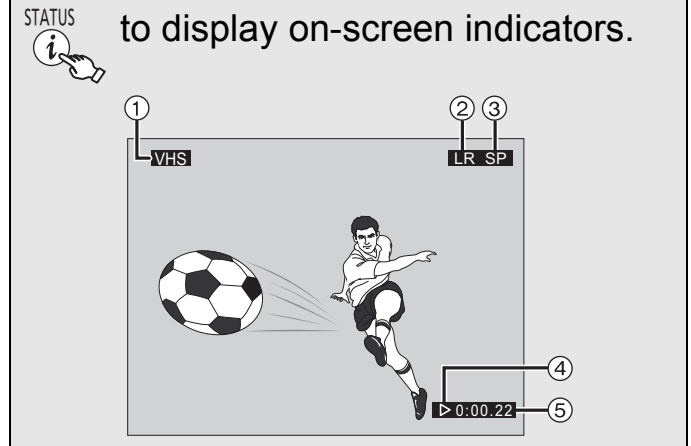

① VHS drive indicator

② L and R indicators

The Left (L) and Right (R) indicators show which sound mode is selected as follows:

L R (Stereo): Hi-Fi stereo audio

L -: Mono L audio of the Hi-Fi stereo audio

- R: Mono R audio of the Hi-Fi stereo audio

-- (Normal): Normal audio

③ Recording mode (⇒ 28)

④ Operation status

⑤ Shows the tape counter and remaining tape time

Pressing [STATUS (i)] to cycle the display as follows:

No display → Tape counter

↑ Remaining tape time ↓

- Press [DELETE *] to reset the tape counter (elapsed time) to "0:00.00". The tape counter is automatically reset when inserting a video cassette.

Notes

Remaining tape time display

- The displayed time is approximate.
- The displayed time will be incorrect if you set the wrong tape length in "Tape Length" in the Setup menu (⇒ 71) and if the tape is of poor quality.

Playing Music files and Still Pictures (JPEG)

Showing the menu screen

-R -R DL CD

- 1 Insert the disc.
- 2 If the menu screen appears
▲, ▼ to select the item, then 

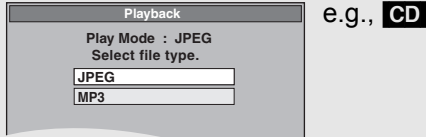

USB

- 1 Insert the USB memory.
- 2 ▲, ▼ to select a file type, then 

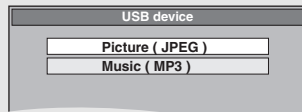

- 3 If the menu screen appears
▲, ▼ to select the item, then 

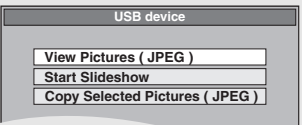

Showing the menu with FUNCTION MENU Display

e.g. selecting a file to play

- 1 Press [RETURN ↵] several times to exit the menu.
- 2 Press [FUNCTION MENU].

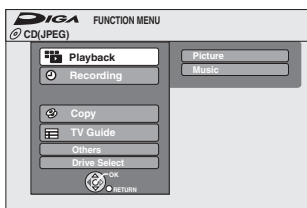

- 3 **-R -R DL CD**
1 Press [▲, ▼] to select "Playback", then press [OK].
2 Press [▲, ▼] to select the file type, then press [OK].

USB

- 1 Press [▲, ▼] to select "Drive Select", then press [OK].
- 2 Press [▲, ▼] to select "USB", then press [OK].
- 3 Press [▲, ▼] to select the file type, then press [OK].
- 4 If you select "Picture (JPEG)" in the step 3 above, press [▲, ▼] to select "View Pictures (JPEG)", then press [OK].

Playing music files

-R -R DL CD USB

You can play MP3 files recorded with a computer onto a DVD-R, DVD-R DL, CD-R/CD-RW and USB memory. (⇒ 18)

- You cannot play MP3 files on the USB memory while recording or copying.

- 1 Show MP3 Menu screen.
(⇒ left, Showing the menu screen)



- 2 ▲, ▼ to select a track, then 
to play.

Tips

- "■" indicates the track currently playing.

To stop playing

Press [■].

To exit the menu screens

Press [DIRECT NAVIGATOR].

To view other pages

Press [◀], [▶].

To select the track with the numbered buttons

e.g., 5: [0] ⇒ [0] ⇒ [0] ⇒ [5]
15: [0] ⇒ [0] ⇒ [1] ⇒ [5]

Notes

When the Power off link (⇒ 46) function is activated, this unit will automatically be set to Standby mode and the music will stop as you set the TV to Standby mode.

Using the Tree Screen to Find a Group

- 1 From the track list
▶ while a track is highlighted to display the tree screen.

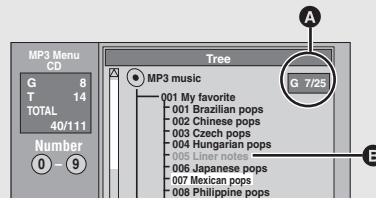

- 2 ▲, ▼ to select a group, then 
– The track list for the selected group appears.

Tips

To return to the track list
Press [RETURN ↵].

Playing still pictures

RAM -R -R DL CD USB

For more information on still picture files that can be played on this unit (⇒ 18)

1 Show Album View screen.

-R -R DL CD USB

(⇒ 42, Showing the menu screen)

RAM

While stopped

- 1 Press [DRIVE SELECT] to select the drive.
- 2 Press [DIRECT NAVIGATOR].

When "PICTURE" is not selected, press the "Green" button to select "PICTURE".

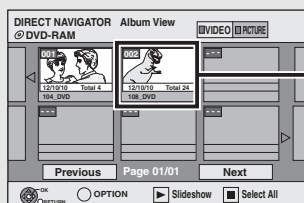

Album View screen
Regarding Album View screen (⇒ below)

2 ▲, ▼, ◀, ▶ to select the album, then OK

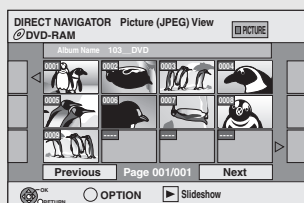

e.g., DVD-RAM

3 ▲, ▼, ◀, ▶ to select the still picture, then OK

Notes

- Still pictures cannot be played during recording or copying.

Tips

DIRECT NAVIGATOR screen icons

- 🔒 Picture and folder protected

To stop viewing a picture

Press [■].

To return to the Album View screen or Picture (JPEG) View screen

Press [RETURN ↵].

To exit the menu screens

Press [DIRECT NAVIGATOR].

To view other pages

Press [▲, ▼, ◀, ▶] to select "Previous" or "Next", then press [OK].
– You can also press [◀◀, ▶▶] to view other pages.

To select the still picture or album with the numbered buttons

Album	Still picture
e.g., 5: [0] ⇒ [0] ⇒ [5]	e.g., 5: [0] ⇒ [0] ⇒ [0] ⇒ [5]
15: [0] ⇒ [1] ⇒ [5]	15: [0] ⇒ [0] ⇒ [1] ⇒ [5]
115: [1] ⇒ [1] ⇒ [5]	115: [0] ⇒ [1] ⇒ [1] ⇒ [5]
	1115: [1] ⇒ [1] ⇒ [1] ⇒ [5]

Regarding Album View screen

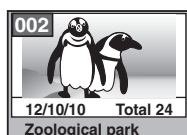

Shooting date/Number of pictures/Album name

- Depending on the digital camera, the editing software on the PC etc., the information about the recording date may not be displayed. In this case, the date will appear as [--/--/--].

Start Slideshow

RAM -R -R DL CD USB

You can display still pictures one by one with regular interval with favourite music.

1 While the Album View screen is displayed ▲, ▼, ◀, ▶ to select an album.



2 You can also start Slideshow with the following steps.

- ① From the Album View screen Press [▲, ▼, ◀, ▶] to select the desired album, then press [OPTION].
- ② Press [▲, ▼] to select "Start Slideshow", then press [OK].

Tips

To select multiple albums for starting Slideshow:

- ① Press [▲, ▼, ◀, ▶] to select the album.
- ② Press [■].
A check mark appears.
• Press [■] again to cancel the selection.
- ③ Repeat steps ①-② until you select all necessary albums.
- ④ Perform step ②.

To select all albums for starting Slideshow:

- ① Press [■] in step ①.
- ② Press [◀, ▶] to select "Yes", then press [OK].
- ③ Perform step ②.

USB

To start Slideshow on the menu screen:

- ① Insert the USB memory.
The menu is automatically displayed. (⇒ 42)
- ② Press [▲, ▼] to select "Start Slideshow", then press [OK].

Slideshow Settings

1 While the Album View screen is displayed OPTION



2 ▲, ▼ to select "Slideshow Settings", then OK



3 ▲, ▼ to select "Picture Settings" or "Background Music Settings", then OK



4 ▲, ▼ to select the item, then ◀, ▶ to select the setting (⇒ 44).

5 After finishing settings ▲, ▼, ◀, ▶ to select "Set", then OK



Playing Music files and Still Pictures (JPEG)

Picture Settings

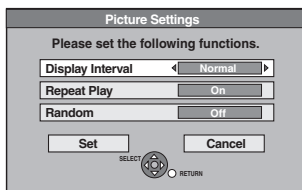

- Display Interval:** Selects the desired interval. ("Normal", "Long" or "Short")
The display interval may vary depending on the picture data size.
- Repeat Play:** Selects "On" to play pictures in the selected album repeatedly.
- Random:** Selects "On" to play pictures in the selected album at random.

Background Music Settings

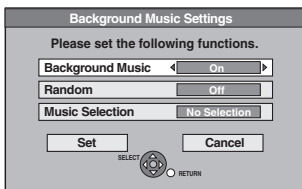

- Background Music:** Selects "On" to play Slideshow with Background Music.
Selects "Off" to play Slideshow without Background Music.
- Random:** Selects "On" to play Background Music at random.
- Music Selection:**
- ① Press [▲, ▼] to select "Music Selection", then press [OK].
 - ② Press [▲, ▼] to select the storage location of Background Music, then press [OK].
 - ③ Press [▲, ▼] to select an album for Background Music, then press [OK].

Notes

- Music albums on the same media cannot be used as the Background Music. (Even if a music album on the same media is selected, the music is not played.)
- DTS-CD cannot be played back as Slideshow Background Music.

Rotate Pictures

- ① While playing a picture
OPTION
- ② ▲, ▼ to select "Rotate RIGHT" or "Rotate LEFT", then [OK]

Tips

To return to the picture to its original position
Press [▲, ▼] to select the opposite rotation in step ②, then press [OK].

Notes

- Rotation information will not be stored.
 - R R DL CD USB Still pictures
 - When disc or album is protected
 - When played on other equipment
 - When copying pictures
 - Rotate RIGHT/Rotate LEFT does not work during Slideshow.

Zoom

- ① While playing a picture
OPTION
- ② To zoom in:
▲, ▼ to select "Zoom in", then [OK]

Tips

To return to the picture to its original size
Press [▲, ▼] to select "Zoom out" in step ②, then press [OK].

Notes

- When zooming in, the still picture may be cut off.
- "Zoom in" information is not stored.
- "Zoom in" and "Zoom out" do not work with images that have a resolution larger than 640x480 pixels.
- "Zoom in" and "Zoom out" do not work during Slideshow.

Picture Properties

Picture information is shown (e.g., shooting date).

While playing a picture
STATUS **twice** to display picture properties.

e.g., DVD-RAM

18:53:50	11/10
Folder - Picture No.	103 - 0006
Date	1/1/2010
No.	3/9

Shooting Date

- Depending on the camera or editing software; shooting dates may not be displayed correctly.

Or

- ① From the Picture (JPEG) View screen
▲, ▼, ◀, ▶ to select the picture, then OPTION
- ② ▲, ▼ to select "Properties", then [OK]

Information (e.g., image size and file size) is shown.



- To exit the Properties screen, press [OK].

Convenient Functions

FUNCTION MENU Display

By using the FUNCTION MENU you may access the main functions quickly and easily.

- If "FUNCTION MENU Display" is set to "On" in the Setup menu, FUNCTION MENU automatically appears when you turn the power on. (⇒ 69)

- 1 With the unit stopped

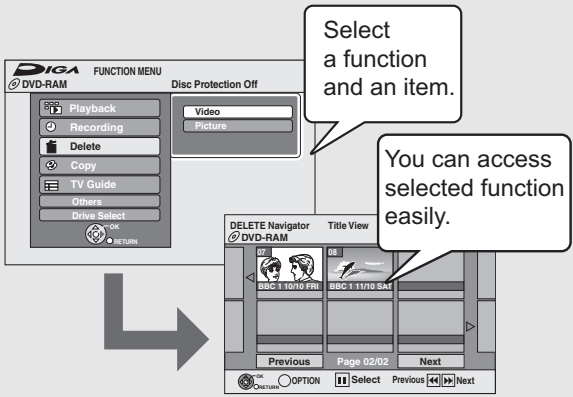
- 2 ▲, ▼ to select a function, then

- 3 ▲, ▼ to select an item, then



Select a function and an item.

You can access selected function easily.

Others

Select and execute a function other than those above, such as Flexible Recording or setting.

- Playlists (⇒ 53)
- Flexible Rec (⇒ 30)
- DVD Management (⇒ 64)
- Setup (⇒ 66)

Drive Select

Change which drive is used.

- DVD
- VHS
- USB

Tips

To exit the FUNCTION MENU
Press [FUNCTION MENU].

Playback

Select when you wish to playback the contents. The DIRECT NAVIGATOR screen or menu screen etc. will be displayed.

- Video (⇒ 20)
- Music (⇒ 42)
- Picture (⇒ 43)
- Menu (⇒ 20)
- Top Menu (⇒ 20)

Recording

Select when you wish to perform manual timer recording, or check the timer recording. The timer recording list will be displayed. (⇒ 33, 34)

Delete

Select the title or file type you wish to delete. The DELETE Navigator screen will be displayed.

- Video (⇒ 26)
- Picture (⇒ 56)

Copy

Select when you wish to copy in the way other than One Touch Copy. (⇒ 24)

- Advanced Copy (⇒ 57)

TV Guide

Select when you wish to watch or record a programme. The TV Guide will be displayed. (⇒ 19, 23)

Linked Operations with the TV (VIERA Link “HDAVI Control™”/Q Link)

You can enjoy linked operations with the TV and receiver by using “VIERA Link” or Q Link.

What is VIERA Link “HDAVI Control”? **VIERA Link**

VIERA Link “HDAVI Control” is a convenient function that offers linked operations of this unit, and a Panasonic TV (VIERA) or receiver under “HDAVI Control”. You can use this function by connecting the equipment with the HDMI cable. See the operating instructions for connected equipment for operational details.

- VIERA Link “HDAVI Control”, based on the control functions provided by HDMI which is an industry standard known as HDMI CEC (Consumer Electronics Control), is a unique function that we have developed and added. As such, its operation with other manufacturers' equipment that supports HDMI CEC cannot be guaranteed.
- This unit supports “HDAVI Control 5” function.
- “HDAVI Control 5” is the newest standard (current as of December, 2009) for Panasonic's HDAVI Control compatible equipment.
- This standard is compatible with Panasonic's conventional HDAVI equipment.
- Please refer to individual manuals for other manufacturers' equipment supporting VIERA Link function.

Preparation:

- 1 Connect this unit to your TV using an HDMI cable and a fully wired 21-pin Scart cable, or to your receiver using an HDMI cable (⇒ 12, 77).
- 2 Set “VIERA Link” to “On” (⇒ 70). (The default setting is “On”.)
- 3 Set the “HDAVI Control” operations on the connected equipment (e.g., TV).
 - Set the input channel on VIERA to suit the terminal to be used as “HDAVI Control”.
- 4 Turn on all “HDAVI Control” compatible equipment and select this unit's input channel on the connected TV so that the “HDAVI Control” function works properly.
Also when the connection or settings are changed, repeat this procedure.

What is Q Link? **Q Link**

Q Link is a convenient function that offers linked operations of this unit and a Panasonic TV. You can use this function by connecting the equipment with a fully wired 21-pin Scart cable.

Preparation:

- Connect this unit to your TV with a fully wired 21-pin Scart cable (⇒ 10, 11).

Notes

The following systems from other manufacturers have similar function to Q Link from Panasonic.

For details, refer to your television's operating instructions or consult your dealer.

- Q Link (registered trademark of Panasonic)
- DATA LOGIC (registered trademark of Metz)
- Easy Link (registered trademark of Philips)
- Megalogic (registered trademark of Grundig)
- SMARTLINK (registered trademark of Sony)

Notes

- These functions may not work normally depending on the equipment condition.
- About “HDAVI Control” function, read the manual of the connected equipment (e.g., TV) too.

(When the TV is on) Easy playback

VIERA Link **Q Link**

When the TV is on and the following operations are performed, the TV's input will automatically switch to HDMI input mode (**VIERA Link**) or AV input mode (**Q Link**) and the TV displays the corresponding action. (Picture or sound may not be available for the first few seconds.)

Press [FUNCTION MENU]*1, [▶] (PLAY)*2, [DIRECT NAVIGATOR], [GUIDE], [PROG/CHECK] etc.

(When the TV is off) Power on link

VIERA Link **Q Link**

When the TV is off and the following operations are performed, the TV will automatically turn on and displays the corresponding action. (Picture or sound may not be available for the first few seconds.)

Press [FUNCTION MENU]*1, [▶] (PLAY)*2, [DIRECT NAVIGATOR], [GUIDE], [PROG/CHECK] etc.

- **DVD-V** **CD** **VCD** **VHS** **SVCD** and **MP3**

The TV is automatically turned on when you insert the discs or VHS.

Power off link **VIERA Link** **Q Link**

When you set the TV to standby mode, the unit is also automatically set to standby mode. The unit is automatically set to standby mode even if the FUNCTION MENU etc. is displayed, during playback or when the unit is set to a timer recording. Even if the TV is turned off, the unit will not be turned off at the same time when recording, copying, finalising etc.

- When this unit is connected to an “HDAVI Control” compatible Panasonic receiver with an HDMI cable, the receiver will also turn off.

Direct TV Recording **VIERA Link** *3 **Q Link**

RAM **-R** **-R DL** **-RW(V)** **+R** **+R DL** **+RW**
This function allows you to immediately start recording the programme that you are viewing on the TV.

- Depending on the TV type connected with this unit, this function may not work.

Press and hold [● DIRECT TV REC] for 1 second.
Recording starts.

To stop recording

Press [■].

- If you switch TV channels while using Direct TV Recording, the Direct TV Recording stops.
- When “EXT-L” lights on the unit's display (⇒ 31), Direct TV Recording is unavailable.

*1 This button is available only when this unit is on.

*2 When this button is pressed, the playback image is not immediately displayed on the screen and it may not be possible to watch the contents from where playback started. In this case, press [◀◀] or [◀] to go back to where playback started.

*3 This function is available with the TV that supports “HDAVI Control 3” or later.

Easy control only with VIERA remote control

If you connect this unit to the TV that supports "HDAVI Control 2" or later with an HDMI cable, you can enjoy using more convenient functions.

You can operate this unit using buttons on the TV remote control.

The buttons that you can use for this unit vary depending on the TV. For details, refer to the operating instructions of the TV. Use the remote control supplied with this unit if you cannot operate this unit using buttons on the TV remote control.

- The operation of this unit may be interrupted when you press incompatible buttons on the TV remote control.
- The TV displays the TV tuner's picture when the linked operation is finished.

Using the FUNCTION MENU to operate this unit

VIERA Link

This function is available with the TV that supports "HDAVI Control 2" or later.

1 Display this unit's "FUNCTION MENU" using the TV remote control.

- If this unit is turned off, this unit will turn on automatically.
- About the FUNCTION MENU Display (⇒ 45, 69)

2 Select the item you want to operate with the TV remote control, then press [OK].

Using the OPTION menu window to operate this unit

VIERA Link

This function is available with the TV that supports "HDAVI Control 2" or later.

By using the TV remote control, you can play discs using the "Control Panel" (⇒ right) and display the Top Menu for DVD-Video.

1 Display this unit's "FUNCTION MENU" using the TV remote control. (⇒ above)

2 Press [OPTION].

- You cannot use the OPTION menu while the Top Menu for DVD-Video is displayed or while DVD-Video is being copied.

3 Select an item, then press [OK].

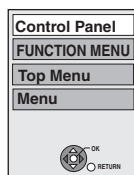

Switch to TV	Displayed when watching with the tuner of this unit. It will return to the TV picture.
Control Panel	Control Panel is displayed. (⇒ right)
FUNCTION MENU	FUNCTION MENU is displayed. (⇒ above)
Top Menu DVD-V	Top Menu is displayed. (⇒ 20)
Menu DVD-V	Menu is displayed. (⇒ 20)
Standby Settings	"Standby Settings" screen is displayed (⇒ 72).
Slideshow	"Album View" screen is displayed (⇒ 43).
Rotate RIGHT/Rotate LEFT (JPEG)	Rotate the still pictures. (⇒ 44)
Zoom in/Zoom out (JPEG)	Enlarge or shrink the still picture. (⇒ 44)
Audio Description	Audio Description screen is displayed. (⇒ 48)

Using the Control Panel

Using the "Control Panel", you can operate search backward, search forward, stop, etc, with the TV remote control. Select "Control Panel", then press [OK] in step 2 of "Using the OPTION menu window to operate this unit" (⇒ left).

The Control Panel is displayed (⇒ right)

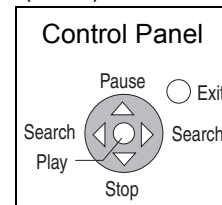

- While playing a title or DVD-Video, etc.

- [▲]: Pause, [▼]: Stop, [◀]: Search backward, [▶]: Search forward, [OK]: Play, [EXIT]: Exit the Control Panel

- While playing still pictures

- [▼]: Stop, [◀]: View previous picture, [▶]: View next picture, [EXIT]: Exit the Control Panel

■ When you want to leave the TV on and set only this unit to standby mode

Press [⏻] on this unit's remote control, then set to standby mode.

■ When not using "HDAVI Control"

Set "VIERA Link" in the Setup menu to "Off" (⇒ 70).

Digital Channel Information

You can display the information about programmes (programme name, broadcast time, etc.).



With the unit stopped

STATUS



to show the screen information.

When the digital channel information is being displayed

– Press [STATUS ] again and detailed information will be displayed (only when “info ” is displayed).

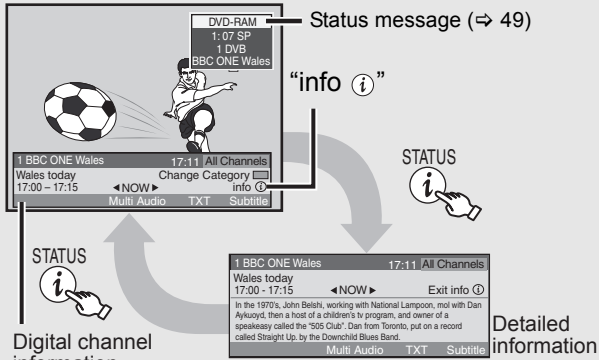

Listening to the Audio Description

This function can aid visually-impaired viewers by adding an audio track to describe events on-screen.

- 1 When “AD” appears in digital channel information to show the OPTION menu.
- 2 ▲, ▼ to select “Audio Description”, then .
– Audio Description screen appears.
- 3 ▲, ▼ to select “Audio Description”.
- 4 ◀, ▶ to select “Auto”, then .

Notes

- Programmes are recorded with Audio Description when you record them with “Audio Description” set to “Auto”.

Tips

• To turn off the Audio Description

In the step 4 (⇒ above), press [◀, ▶] to select “Off”, then press [RETURN ↵].

• To change the volume

In the step 3 (⇒ above), press [▲, ▼] to select “Volume” and press [◀, ▶] to set the volume, then press [RETURN ↵].

- You can switch the Audio Description and change its volume during recording and timer recording.

Showing the Digital Teletext

When “TXT” appears in digital channel information to show the Digital Teletext.



– Press again to hide.

Notes

- During recording the Digital Teletext function is not possible.
- When subtitle is on or the digital channel information is displayed, the Digital Teletext function does not work.

Tips

To view another page of Digital Teletext

Press [▲, ▼] to select another page and press [OK].

- You can also use the numbered buttons to select another page.

Quickly access to certain topic areas and navigation

Use colour buttons according to on-screen instructions.

Showing Subtitles

When “Subtitle” appears in digital channel information to show subtitles.



– Press again to hide.

Notes

- Programmes are recorded with subtitles when you record them with the subtitles setting set to “Subtitles On”.
- You cannot switch subtitles during timer recording.

Tips

To select subtitle language (⇒ 67, DVB Preferred Subtitles)

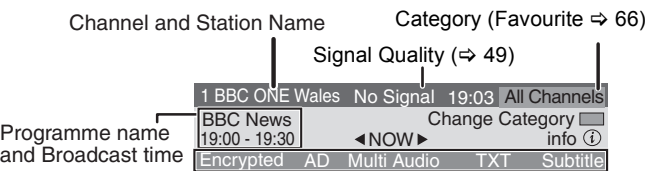

Encrypted	During scrambled broadcasting (You cannot watch the broadcast).
AD	Audio Description service may be available.
Multi Audio	Programme is broadcast in multi-channel sound (⇒ 63, DVB Multi Audio). To select audio language (⇒ 67, DVB Preferred Multi Audio)
TXT	Digital Teletext may be available.
Subtitle	Subtitle may be available.

Even with programmes with “AD”, “Multi Audio”, “TXT” and “Subtitle” indications, you may not be able to use these services. To confirm the availability of these services, refer to the indications in the detailed information too.*

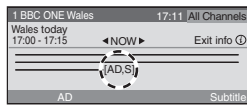

* These indications are not displayed properly unless the information sent from broadcast stations is correct.

Tips

To switch information of the current programme and the next programme

Press [◀, ▶].

- NOW: current programme
- NEXT: next programme

To select the information of another channel

Press [▲, ▼].

- Press [OK] to watch the selected channel.

To change the length of time digital channel information is displayed for

(⇒ 69, On-Screen Messages)

Notes

- Every time you change the channel, digital channel information appears automatically. They disappear again after a short time.
- If you record a digital radio broadcast or a digital broadcast that is not being received correctly, digital channel information is also recorded and will remain visible during playback.

Changing the Category

You can select one of your favourite channels by changing the category [such as Free Channels, Radio and Registered Favourites (⇒ 66)].

When digital channel information is displayed
 to change the category.

Signal Quality

No Signal:	The digital broadcast signal is not being received.
No Service:	No broadcasts are currently available.

Notes

- If “No Signal” is displayed, check that the current digital broadcast channel is correctly broadcasting.

Status Messages

The following messages and displays appear to let you know what operations are being performed and the status of the unit.

During playback and/or recording
 STATUS Several times to cycle through available displays.

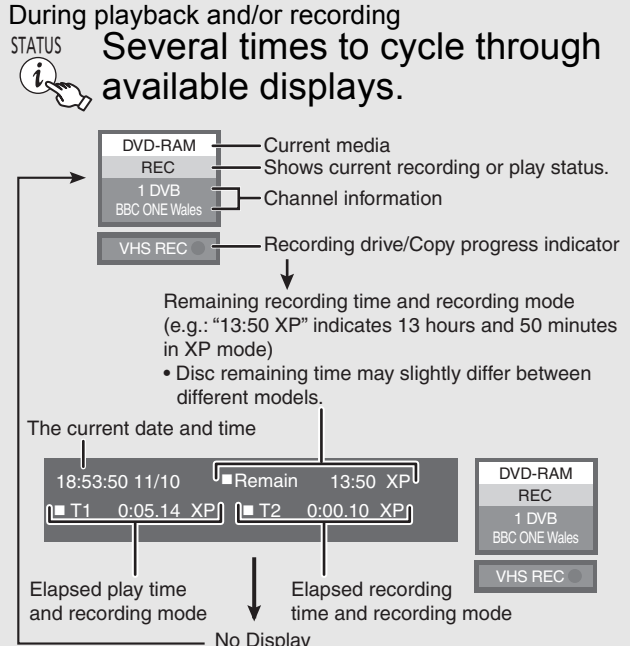

DVD-RAM REC — Current media
 Shows current recording or play status.

1 DVB BBC ONE Wales — Channel information

VHS REC — Recording drive/Copy progress indicator

Remaining recording time and recording mode (e.g.: “13:50 XP” indicates 13 hours and 50 minutes in XP mode)
 • Disc remaining time may slightly differ between different models.

The current date and time

18:53:50 11/10 — Remain 13:50 XP

T1 0:05.14 XP — T2 0:00.10 XP

DVD-RAM REC — Current media
 Shows current recording or play status.

1 DVB BBC ONE Wales — Channel information

VHS REC — Recording drive/Copy progress indicator

Elapsed play time and recording mode — Elapsed recording time and recording mode

No Display

New Channel Message

When a new DVB channel is added this unit will be informed automatically. Then the confirmation message appears. If you select “Yes” on the display, Auto-Setup starts (All channel settings and Favourites are deleted and the timer recording programmes are also cancelled.)



Tips

The display/show/hide setting can be changed (⇒ 69).

Entering Text

You can give names to recorded titles, etc. Also, you can search for desired programmes on GUIDE Plus+ list by entering key words or the programme name. (⇒ 37, Free Word Search)

1 When viewing the “Enter Title Name” screen etc.

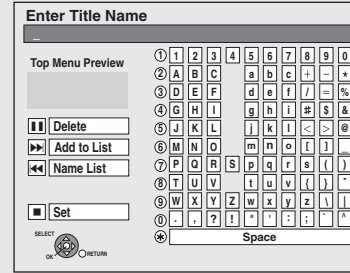

e.g., “Enter Title Name” screen

▲, ▼, ◀, ▶ to select a character, then 

- Repeat this step to enter other characters.

Using the numbered buttons to enter characters
 e.g.: entering the letter “R”

- 1 Press [7] to move to the 7th row.
- 2 Press [7] twice to highlight “R”.
- 3 Press [OK].

To enter a space

Press [DELETE *], then press [OK].

To delete a character

Press [DELETE *] on a character in the name field.

To cancel in the middle

Press [RETURN ↵].

- Characters will not be saved.

2



when you’ve finished entering text.

Tips

■ To add a name to the list

You can add frequently used names and recall them later. Maximum number of added names: 20

Maximum number of characters per name: 44

After entering the name (step 1)

1. Press [▲, ▼, ◀, ▶] to select “Add to List”, then press [OK].
 • You can also press [▶▶] to select “Add to List”.
2. Press [◀, ▶] to select “Add”, then press [OK].
 • Press [RETURN ↵] to cancel.

■ To recall an added name

1. Press [▲, ▼, ◀, ▶] to select “Name List”, then press [OK].
 • You can also press [◀◀] to select “Name List”.
2. Press [▲, ▼, ◀, ▶] to select the name to be recalled, then press [OK].

■ To delete an added name

1. Press [▲, ▼, ◀, ▶] to select “Name List”, then press [OK].
 • You can also press [◀◀] to select “Name List”.
2. Press [▲, ▼, ◀, ▶] to select the name to be deleted.
3. Press [OPTION] to show “Delete Name”, then press [OK].
4. Press [◀, ▶] to select “Delete”, then press [OK].
5. Press [RETURN ↵].

Notes

- The number of characters that can be entered depends on what kind of things you name.

- If you enter a long name, only part of it is shown in the Top Menu after finalisation (⇒ 65). When entering a title name, the name that will appear in the Top Menu can be previewed in “Top Menu Preview” window.

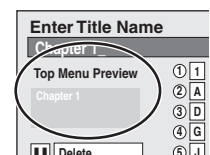

Titles—Editing

RAM

-R -R DL -RW(V) +R +R DL (You can not edit finalised discs.)
+RW -RW(V/R)

You can edit titles on the DIRECT NAVIGATOR screen: deleting unwanted parts of titles such as commercials, changing Thumbnail, dividing and deleting titles, etc.

Tips

- **Maximum numbers of titles on a disc**

RAM -R -R DL -RW(V)	+R +R DL +RW
99	49

Accessing the Title View

Preparation:

- **RAM** Release protection (⇒ 64, Setting Protection).

- 1 Press [DRIVE SELECT] to select the drive.
- 2 Press [DIRECT NAVIGATOR].
RAM When "VIDEO" is not selected, press the "Red" button to select "VIDEO".
- 3 Press [▲, ▼, ◀, ▶] to select a title.
 – Multiple editing (⇒ below, Tips)
- 4 Press [OPTION] to display the menu list.
 - Items that cannot be selected are grey.

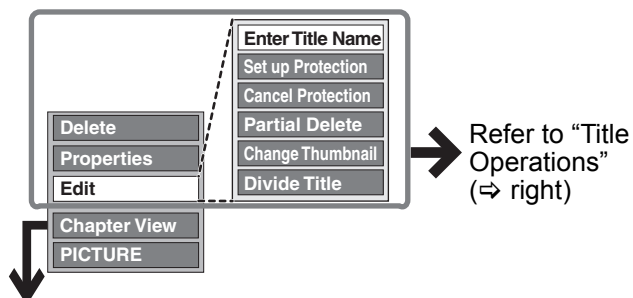

If you select "Chapter View" (⇒ 52)

Notes

- You cannot edit during recording or copying, etc.
- **+R +R DL** Management information is recorded in unused sections when you edit discs. The available space on these discs decreases each time you edit their contents.

Tips

To exit the menu screens
 Press [DIRECT NAVIGATOR].

To view other pages

Press [▲, ▼, ◀, ▶] to select "Previous" or "Next", then press [OK].
 – You can also press [◀◀, ▶▶] to view other pages.

Multiple editing

(Only Delete, Set up Protection, Cancel Protection)
 Select with [▲, ▼, ◀, ▶], then press [■]. (Repeat.)
 – A check mark appears. Press [■] again to cancel.

Title Operations

Delete

RAM -R -R DL -RW(V) +R +R DL +RW

Use to delete unneeded titles.

Important: Once deleted, contents cannot be recovered.

Perform steps 1 – 4 of "Accessing the Title View" (⇒ left).

- 5 Press [▲, ▼] to select "Delete", then press [OK].
- 6 Press [◀] to select "Delete", then press [OK] to confirm.

Notes

- **RAM** Deleting an item increases the available disc space by the amount of space taken by the item deleted.
- **-R -R DL +R +R DL** Available disc space does not increase after deletion.
- **-RW(V) +RW** Available disc space increases when you delete the last title (the recording space may increase slightly when other titles are deleted).
- Available disc space may not increase after deleting a short title.
- **RAM -RW(V) +RW** To recover total disc space, the disc needs to be formatted. (⇒ 64)

Properties

RAM -R -R DL -RW(V) +R +R DL +RW -RW(VR)

To view title information (e.g., date, time)

Perform steps 1 – 4 of "Accessing the Title View" (⇒ left).

- 5 Press [▲, ▼] to select "Properties", then press [OK].

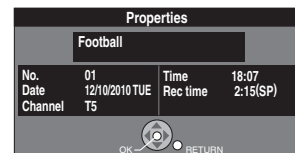
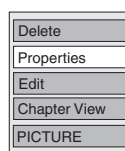

Enter Title Name

RAM -R -R DL -RW(V) +R +R DL +RW

You can give a name for the title.

Perform steps 1 – 4 of "Accessing the Title View" (⇒ left).

- 5 Press [▲, ▼] to select "Edit", then press [OK].
- 6 Press [▲, ▼] to select "Enter Title Name", then press [OK].
 Entering Text (⇒ 49)

Set up Protection/Cancel Protection

RAM +R +R DL +RW

Use to prevent accidental erasure of titles.

Perform steps ① – ④ of “Accessing the Title View” (⇒ 50).

- ⑤ Press [▲, ▼] to select “Edit”, then press [OK].
- ⑥ Press [▲, ▼] to select “Set up Protection” or “Cancel Protection”, then press [OK].
- ⑦ Press [◀] to select “Yes”, then press [OK].

The lock symbol appears when the title is protected.

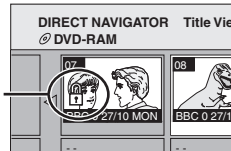

Partial Delete

RAM

Use to remove unwanted parts of titles, such as commercials.
Important: Once deleted, the parts cannot be recovered.

Perform steps ① – ④ of “Accessing the Title View” (⇒ 50).

- ⑤ Press [▲, ▼] to select “Edit”, then press [OK].
- ⑥ Press [▲, ▼] to select “Partial Delete”, then press [OK].

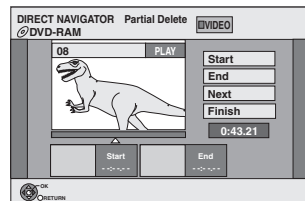
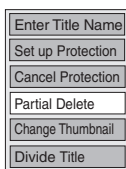

- ⑦ Press [OK] to set the “Start” point and then press [OK] again to set the “End” point of the section you want to erase.
 - For quicker editing (⇒ below, Tips)
 - To delete multiple sections: Press [▲, ▼] to select “Next”, and repeat this step.
- ⑧ Press [▲, ▼] to select “Finish”, then press [OK].
- ⑨ Press [◀] to select “Delete”, then press [OK] to confirm.

Notes

- You may not be able to specify start and end points within 3 seconds of each other.
- Available disc space may not increase after erasing short parts of titles.

Tips

For quicker editing

- Use Search (⇒ 38) or Time Slip (⇒ 39) to find the desired point.
- To skip to the start or end of a title/chapter press [◀◀] (start) or [▶▶] (end).
- For better precision, use Slow-motion (⇒ 39) and Frame-by-Frame (⇒ 39).

Change Thumbnail

RAM -R -R DL -RW(V) +R +R DL +RW

Changes the thumbnail picture shown in the Title View screen.

Perform steps ① – ④ of “Accessing the Title View” (⇒ 50).

- ⑤ Press [▲, ▼] to select “Edit”, then press [OK].
- ⑥ Press [▲, ▼] to select “Change Thumbnail”, then press [OK].

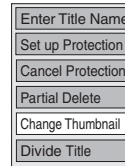

- ⑦ Press [▶] (PLAY) to start play.
- ⑧ Press [OK] at the point you want to use as the thumbnail.
 - For quicker editing (⇒ below, Tips)
 - To change the thumbnail: Restart play and press [▲, ▼] to select “Change”, then press [OK] at the point you want to use as the thumbnail.
- ⑨ Press [▲, ▼] to select “Finish”, then press [OK].

Divide Title

RAM

You can divide a title into two.
Once divided, titles cannot be recombined.

Perform steps ① – ④ of “Accessing the Title View” (⇒ 50).

- ⑤ Press [▲, ▼] to select “Edit”, then press [OK].
- ⑥ Press [▲, ▼] to select “Divide Title”, then press [OK].

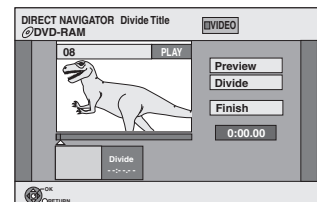
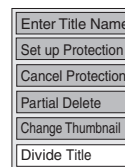

- ⑦ Press [OK] at the point you want to divide.
 - For quicker editing (⇒ below, Tips)
 - Selecting “Preview”, then pressing [OK] plays the title from 10 seconds prior, to 10 seconds after the division point.
 - To change the point to divide at: Press [▲, ▼] to select “Divide”, then press [▶] (PLAY) to bring to the point where you want to divide, then press [OK].
- ⑧ Press [▲, ▼] to select “Finish”, then press [OK].
- ⑨ Press [◀] to select “Divide”, then press [OK].
 - The title is divided at that point.

Notes

- Divided titles retain the name of the original.
- A short amount of video and audio just before and after the division point get cut out.
- You cannot divide a title when the resulting parts are too short or total number of titles exceeds 99.

Chapters—Creating and Editing

RAM

When creating chapters in your favourite scenes, you can easily reach the head of scene using [**◀◀**, **▶▶**] (SKIP) or play on Chapter View.

Tips

• Chapter

Each section between the division points becomes a chapter.

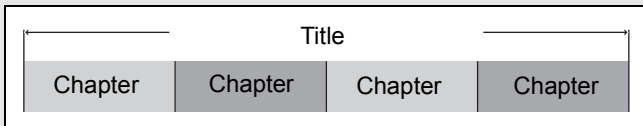

- **RAM**: You can change the order of chapters and create a playlist (⇒ 53).

“Chapter Creation” in the Setup menu (⇒ 68)

“Automatic”:

Detects changes (special mute points like the start and the end of the programme) in the scene during recording and sets chapter start points on them automatically.

- Depending on the programme to be recorded or the Recording Mode, the chapter start points may not be created correctly.

“5 minutes”:

Sets chapter start points automatically during recording at approximately 5-minute interval.

- **Maximum numbers of chapters on a disc**

RAM -R -R DL -RW(V): Approx. 1000

+R +R DL +RW: Approx. 254

Accessing the Chapter View

Allows viewing and editing chapters individually.

- 1 Press **[DRIVE SELECT]** to select the DVD drive.
- 2 Press **[DIRECT NAVIGATOR]**.
RAM When “VIDEO” is not selected, press the “Red” button to select “VIDEO”.
- 3 Press **[▲, ▼, ◀, ▶]** to select a title.
- 4 Press **[OPTION]** to display the **OPTION** menu.
- 5 Press **[▲, ▼]** to select “Chapter View” then press **[OK]**.
- 6 Press **[▲, ▼, ◀, ▶]** to select a chapter.
– Multiple editing (⇒ right, Tips)
- 7a **To play**
Press **[OK]**.
- 7b **To edit**
Press **[OPTION]** to display the menu list.

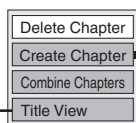
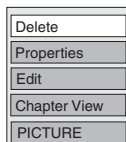

Refer to “Chapter Operations” (⇒ right).

You can go back to the Title View.

Tips

To exit the menu screens

Press **[DIRECT NAVIGATOR]**.

To view other pages

Press **[▲, ▼, ◀, ▶]** to select “Previous” or “Next”, then press **[OK]**.

- You can also press [**◀◀**, **▶▶**] to view other pages.

Multiple editing

(Only Delete Chapter)

Select with **[▲, ▼, ◀, ▶]**, then press **[■]**. (Repeat.)

- A check mark appears. Press **[■]** again to cancel.

Chapter Operations

Delete Chapter

You can delete the chapters for each title.

Important: Once deleted, recorded contents cannot be recovered.

Perform steps **1** – **7b** of “Accessing the Chapter View” (⇒ left).

- 8 Press **[▲, ▼]** to select “Delete Chapter”, then press **[OK]**.
- 9 Press **[◀]** to select “Delete”, then press **[OK]**.

Create Chapter

You can divide a title into multiple chapters.

Perform steps **1** – **7b** of “Accessing the Chapter View” (⇒ left).

- 8 Press **[▲, ▼]** to select “Create Chapter”, then press **[OK]**.

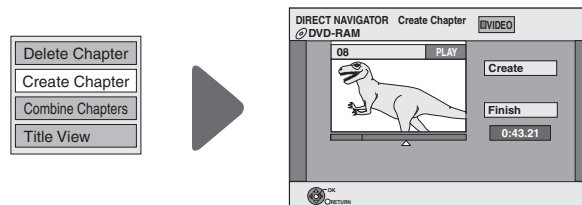

- 9 Press **[OK]** at the point you want to divide.
– For quicker editing (⇒ 51, Tips)
– Repeat this step to create additional chapters.
- 10 Press **[▲, ▼]** to select “Finish”, then press **[OK]**.

Notes

- A short portion of the title just after the creation point may be lost.

Combine Chapters

You can combine the divided chapters.

Perform steps **1** – **7b** of “Accessing the Chapter View” (⇒ left).

- 8 Press **[▲, ▼]** to select “Combine Chapters”, then press **[OK]**.
- 9 Press **[◀]** to select “Combine”, then press **[OK]**.
– The selected chapter gets combined with the next chapter.

Creating, Editing and Playing Playlists

RAM

-RW(VR) (play only)

You can create playlists by grouping your favourite scenes (chapters) from the recorded titles and edit the created playlists.

Tips

RAM

A playlist is a compilation of your favourite chapters as shown in the chart below.

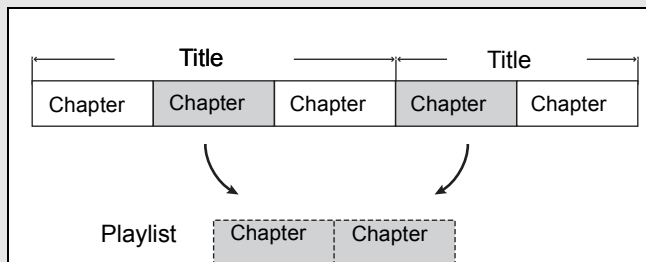

- Editing playlists doesn't modify titles.
- Playlists are not recorded separately so this doesn't use much capacity.

Accessing the Playlist View

Preparation:

- Press [DRIVE SELECT] to select the drive containing the recorded title to be edited.
- **RAM** Release protection (⇒ 64, Setting Protection).

With the unit stopped

- 1 Press [FUNCTION MENU].
- 2 Press [▲, ▼] to select "Others", then press [OK].
- 3 Press [▲, ▼] to select "Playlists", then press [OK].

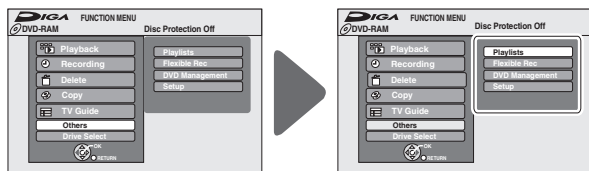

- 4a To play**
Press [▲, ▼, ◀, ▶] to select the playlist to play, then press [OK].
- 4b To create**
Press [▲, ▼, ◀, ▶] to select "Create", then press [OK] (⇒ right, Creating Playlists).
- 4c To edit**
Press [▲, ▼, ◀, ▶] to select the playlist, then press [OPTION].
– Multiple editing (⇒ 54, Tips in "Edit")

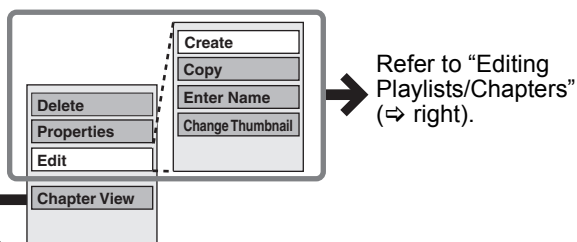

If you select "Chapter View" (⇒ 54)

Creating Playlists

RAM

Perform steps 1 – 4b of "Accessing the Playlist View". (⇒ left)

- 5 Press [◀, ▶] to select the source title, then press [▼].
– Press [OK] to select all the chapters in the title, then skip to step 7.
- 6 Press [◀, ▶] to select the source chapter you want to add to a playlist, then press [OK].
– Press [▲] to cancel.
– Press [OPTION] to select "Create Chapter", then press [OK] if you want to create a new chapter in the source title (⇒ 52).
- 7 Press [◀, ▶] to select the position to insert the chapter, then press [OK].
– Press [▲] repeatedly to return to step 5, if you want to add additional source titles.

Chapters are registered to the playlist. Repeat steps 6 and 7 to add other chapters.

- 8 Press [RETURN ↵] to finish and exit the screen.

Notes

- Playlists cannot be created while recording or copying.
- You are allowed a maximum of 99 playlists, with approximately 1000 chapters per playlist.

Editing Playlists/Chapters

Delete

RAM

Use to delete unneeded playlists.

Important: Once deleted, playlists contents cannot be recovered (titles are not affected).

Perform steps 1 – 4c of "Accessing the Playlist View". (⇒ left)

- 5 Press [▲, ▼] to select "Delete", then press [OK].
- 6 Press [◀] to select "Delete", then press [OK] to confirm.

Tips

To delete during play

1. Press [DELETE *]. A confirmation message displays.
2. Press [◀] to select "Delete", then press [OK] to confirm.

Properties

RAM -RW(VR)

Playlist information (e.g., length and date) is shown.

Perform steps 1 – 4c of "Accessing the Playlist View". (⇒ left)

- 5 Press [▲, ▼] to select "Properties", then press [OK].

Tips

To exit the screen
Press [OK].

Creating, Editing and Playing Playlists

Edit

RAM

You can create and copy playlists, and change the thumbnail.

Perform steps ① – ④c of “Accessing the Playlist View” (⇒ 53).

- ⑤ Press [▲, ▼] to select “Edit”, then press [OK].
- ⑥ Press [▲, ▼] to select desired operation from the menu displayed location, then press [OK] (⇒ below).

Create	① Press [▲, ▼] to select “Create”, then press [OK]. (⇒ 53, Creating Playlists)
Copy	① Press [▲, ▼] to select “Copy”, then press [OK]. ② Press [◀] to select “Copy”, then press [OK].
Enter Name	① Press [▲, ▼] to select “Enter Name”, then press [OK]. ② Enter a name for the playlist. (⇒ 49, Entering Text).
Change Thumbnail	① Press [▲, ▼] to select “Change Thumbnail”, then press [OK]. ② Press [▶] (PLAY). Use Time Slip (⇒ 39), Slow-motion (⇒ 39), Frame-by-Frame (⇒ 39), or Search (⇒ 38) to find the desired point. ③ Press [OK] at the image you wish you use for your thumbnail. ④ Press [▲, ▼] to select “Finish”, then press [OK]. – The thumbnail picture is now changed.

Tips

To exit the menu screens

Press [EXIT].

To view other pages

Press [▲, ▼, ◀, ▶] to select “Previous” or “Next”, then press [OK].

– You can also press [◀◀, ▶▶] to view other pages.

Multiple editing

(Only Delete, Copy)

Select with [▲, ▼, ◀, ▶], then press [■]. (Repeat.)

– A check mark appears. Press [■] again to cancel.

Chapter View

RAM

You can add, move, divide, combine or delete chapters in the playlist.

Perform steps ① – ④c of “Accessing the Playlist View” (⇒ 53).

- ⑤ Press [▲, ▼] to select “Chapter View”, then press [OK].
- ⑥ Press [▲, ▼, ◀, ▶] to select a chapter.
– Multiple editing (⇒ right, Tips)
- ⑦a To play
Press [OK].
- ⑦b To edit
Press [OPTION] to display the menu list.

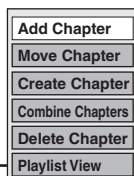

Refer to “Chapter Operations” (⇒ right)

You can go back to the Playlist View.

Chapter Operations

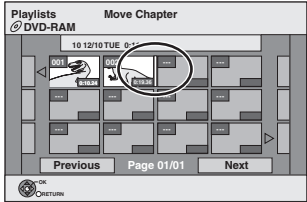
Add Chapter	① Press [▲, ▼] to select “Add Chapter”, then press [OK]. (⇒ 53, Creating Playlists)
Move Chapter	① Press [▲, ▼] to select “Move Chapter”, then press [OK]. ② Press [▲, ▼, ◀, ▶] to select the position to insert the chapter, then press [OK]. 
Create Chapter	① Press [▲, ▼] to select “Create Chapter”, then press [OK]. ② Press [▶] (PLAY). Use Time Slip (⇒ 39), Slow-motion (⇒ 39), Frame-by-Frame (⇒ 39), or Search (⇒ 38) to find the desired point. ③ Press [OK] at the point you want to divide. ④ Press [▲, ▼] to select “Finish”, then press [OK].
Combine Chapters	① Press [▲, ▼] to select “Combine Chapters”, then press [OK]. ② Press [◀] to select “Combine”, then press [OK]. – The selected chapter gets combined with the next chapter.
Delete Chapter	① Press [▲, ▼] to select “Delete Chapter”, then press [OK]. ② Press [◀] to select “Delete”, then press [OK].

Tips

To exit the menu screens

Press [EXIT].

To view other pages

Press [▲, ▼, ◀, ▶] to select “Previous” or “Next”, then press [OK].

– You can also press [◀◀, ▶▶] to view other pages.

Multiple editing

(Only Delete Chapter)

Select with [▲, ▼, ◀, ▶], then press [■]. (Repeat.)

– A check mark appears. Press [■] again to cancel.

Accessing the Album (still picture)/Picture View

RAM

You can edit pictures and albums.

Preparation:

- Press [DRIVE SELECT] to select the DVD drive.
- Release protection (⇒ 64, Setting Protection)

1 Press [DIRECT NAVIGATOR].

When “PICTURE” is not selected, press the “Green” button to select “PICTURE”.

Editing an album:

2a Press [▲, ▼, ◀, ▶] to select the album.

- Multiple editing (⇒ below, Tips)
- When you want to create an album using “Create Album”, press [OPTION] without selecting album.

Editing a still picture:

2b 1. Press [▲, ▼, ◀, ▶] to select the album which contains the still picture to edit, then press [OK].

2. Press [▲, ▼, ◀, ▶] to select the still picture.
 - Multiple editing (⇒ below, Tips)

3 Press [OPTION] to display the menu list.

- Items that cannot be selected are grey. e.g., Editing an album

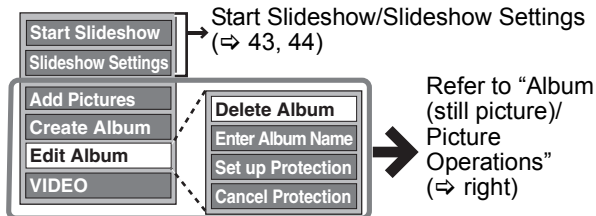

e.g., Editing a still picture

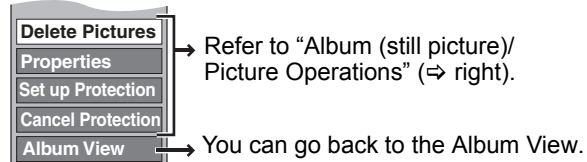

Notes

- You cannot edit still pictures recorded on DVD-R DL, CD-R/CD-RW and USB memory.

Tips

To view other pages

Press [▲, ▼, ◀, ▶] to select “Previous” or “Next”, then press [OK].

- You can also press [◀◀, ▶▶] to view other pages.

Multiple editing

[Only Delete Album, Delete Pictures, Set up Protection, Cancel Protection.]

Select with [▲, ▼, ◀, ▶], then press [■]. (Repeat.)

- A check mark appears. Press [■] again to cancel.

To select all albums

Press [■]. After confirmation message appears, press [◀] to select “Yes”.

To return to the previous screen

Press [RETURN ↵].

To exit the menu screens

Press [DIRECT NAVIGATOR].

Album (still picture)/Picture Operations

Notes

- Timer recordings do not start when performing “Add Pictures” or “Create Album”.

Add Pictures/Create Album

RAM

Perform steps 1 – 3 of “Accessing the Album (still picture)/Picture View” (⇒ left).

4 Press [▲, ▼] to select “Add Pictures” or “Create Album”, then press [OK].

5 Press [◀] to select “Start” or “Yes”, then press [OK].

6 Press [▲, ▼, ◀, ▶] to select the album containing picture to add, then press [OK].

7 Press [▲, ▼] to select “Select pictures to copy” or “Copy all pictures”, then press [OK].

- If “Select pictures to copy” is selected Press [▲, ▼, ◀, ▶] to select the picture, then press [OK].

- If “Copy all pictures” is selected All the still pictures in the album will be copied.

8 Press [▶] to select “No” to finish copying, then press [OK].

- If you want to continue copying, select “Yes”, then repeat steps 6 – 8.

Only when you select “Create Album”

9 Press [◀, ▶] to select “Yes” or “No”, then press [OK].

- If “Yes” is selected You can give a name for the album (⇒ 49, Entering Text).
- If “No” is selected The album name is automatically given.

Notes

- “Add Pictures” is available only for the folders conforming to DCF.

Delete Album/Delete Pictures

RAM -R (JPEG)

Important: Once deleted, contents cannot be recovered.

- When deleting an album, non-picture files in the album will also be deleted. (This does not apply to subordinate folders in the album.)
- **-R** Available space does not increase even after pictures are deleted.

Perform steps 1 – 3 of “Accessing the Album (still picture)/Picture View” (⇒ left).

- When editing an album, press [▲, ▼] to select “Edit Album”, then press [OK] after step 3.

4 Press [▲, ▼] to select “Delete Album” or “Delete Pictures”, then press [OK].

5 Press [◀] to select “Delete”, then press [OK].

Enter Album Name

RAM

Perform steps 1 – 3 of “Accessing the Album (still picture)/Picture View” (⇒ left).

- When editing an album, press [▲, ▼] to select “Edit Album”, then press [OK] after step 3.

4 Press [▲, ▼] to select “Enter Album Name”, then press [OK].

- You can give a name for the album (⇒ 49, Entering Text).

Notes

- Album names entered using this unit may not be displayed on other equipment.

Still Pictures—Editing

Set up Protection/Cancel Protection

RAM

Set protection to prevent pictures from being accidentally deleted.

Perform steps ① – ③ of “Accessing the Album (still picture)/ Picture View” (⇒ 55).

- When editing an album, press [▲, ▼] to select “Edit Album”, then press [OK] after step ③.
- ④ Press [▲, ▼] to select “Set up Protection” or “Cancel Protection”, then press [OK].
- ⑤ Press [◀] to select “Yes”, then press [OK].
 - The lock symbol “🔒” appears when the still picture or album is protected.

Notes

- Even if you set protection using this unit, album may be deleted by other equipment.

Properties

RAM -R -R DL CD USB

Information (e.g., image size and file size) is shown.

Perform steps ① – ③ of “Accessing the Album (still picture)/ Picture View” (⇒ 55).

- ④ Press [▲, ▼] to select “Properties”, then press [OK].
 - To exit the Properties screen, press [OK].

Deleting still pictures using DELETE Navigator

RAM

Preparation:

- Release protection (⇒ 64, Setting Protection)

Important: Once deleted, contents cannot be recovered.

- ① Press [DRIVE SELECT] to select the DVD.
- ② Press [FUNCTION MENU].
- ③ Press [▲, ▼] to select “Delete”, then press [OK].
- ④ Press [▲, ▼] to select “Picture”, then press [OK].

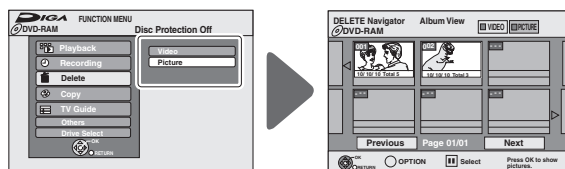

Deleting an album:

- ⑤a Press [▲, ▼, ◀, ▶] to select the item, then press [DELETE *].

Deleting a still picture:

- ⑤b 1. Press [▲, ▼, ◀, ▶] to select the album which contains the still picture to delete, then press [OK].
- 2. Press [▲, ▼, ◀, ▶] to select the still picture, press [OK].
- ⑥ Press [◀, ▶] to select “Delete”, then press [OK].

Notes

- You cannot delete while recording or copying.

Tips

To view other pages

Press [▲, ▼, ◀, ▶] to select “Previous” or “Next”, then press [OK].

- You can also press [◀◀, ▶▶] to view other pages.

Multiple editing

Select with [▲, ▼, ◀, ▶], then press [II]. (Repeat.)

- A check mark appears. Press [II] again to cancel.
- **RAM** Deleting an item increases the available space by the amount of space taken by the item deleted.

To return to the previous screen

Press [RETURN ↵].

To exit the screen

Press [EXIT].

Copying Titles or Playlists

Preparation:

- Insert a disc and video cassette that you can use for copying (⇒ 7).
- Confirm that there is enough remaining disc or tape space.
- When copying an NTSC tape to a DVD, change the “TV System” to “NTSC” in the Setup Menu (⇒ 70).
This unit cannot record NTSC signals to discs that already have PAL signal recordings.

Copying Titles (VHS → DVD)

VHS → RAM -R -R DL -RW(V) +R +R DL +RW

- 1 Press [FUNCTION MENU].
- 2 Press [▲, ▼] to select “Copy”, then press [OK].
- 3 Press [▲, ▼] to select “Advanced Copy”, then press [OK].

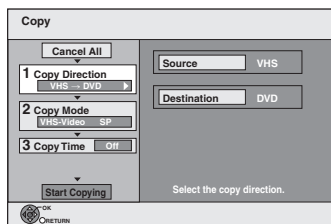

- 4 **Set the copy direction.**
 - If you are not going to change the copying direction, press [▼] (⇒ step 5).
 - ① Press [▲, ▼] to select “Copy Direction”, then press [▶].
 - ② Press [▲, ▼] to select “Source”, then press [OK].
 - ③ Press [▲, ▼] to select “VHS”, then press [OK].
– “Destination” is automatically set to “DVD”.
 - ④ Press [◀] to confirm.
- 5 **Set the recording mode.**
 - If you are not going to change the recording mode, press [▼] (⇒ step 6).
 - ① Press [▲, ▼] to select “Copy Mode”, then press [▶].
– “Format” is automatically set to “VHS-Video”.
 - ② Press [▲, ▼] to select “Recording Mode”, then press [OK].
 - ③ Press [▲, ▼] to select the mode, then press [OK].
 - ④ Press [◀] to confirm.
- 6 **Set “Copy Time”.**
 - If you are not going to change the setting press [▼] (⇒ step 7).
 - ① Press [▲, ▼] to select “Copy Time”, then press [▶].
 - ② Press [▲, ▼] to select “Time Setting”, then press [OK].
 - Setting the unit to copy all the content on the video cassette
 - ③ Press [▲, ▼] to select “Off”, then press [OK].
 - ④ Press [◀] to confirm.
 - Setting the unit to copy according to the set time
 - ③ Press [▲, ▼] to select “On”, then press [OK].
 - ④ Press [▲, ▼] to select “Copy Time”, then press [OK].

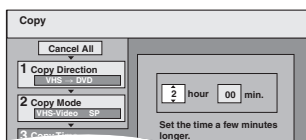

- 5 Press [◀, ▶] to select “hour” and “min.”, then press [▲, ▼] to set the recording time.
 - 6 Press [OK].
 - 7 Press [◀] to confirm.
- You can also set the recording time with the numbered buttons.
- 7 Press [▲, ▼] to select “Start Copying”, then press [OK].

- 8 Press [◀] to select “Yes”, then press [OK] to start copying.

– Copying continues until the set time even if the playback of the programme you wish to copy finishes. Note that copying is automatically stopped when the tape reaches the end or the remaining capacity of the copy destination is filled.

- 9 VHS → -R -R DL -RW(V) +R +R DL

Press [◀, ▶] to select “Copy & Finalise” or “Copy Only”, then press [OK].

- If “Copy & Finalise” is selected

After finalising, the discs become play-only and you can also play them on other DVD equipment. However, you can no longer record or edit.

Tips

To stop copying

Press and hold [RETURN ↵] for 3 seconds.
(You cannot stop while finalising.)

To return to the previous screen

Press [RETURN ↵].

Notes

- To play DVD-R, DVD-R DL, DVD-RW (DVD-Video format) +R and +R DL on other players, it is necessary to finalise them after copy.

About FR mode

When “Time Setting” is set to “Off” in step 6 (⇒ left):

- The recording mode is automatically selected by estimating the remaining capacity of the disc for copying of only the recorded parts in the video cassette (unrecorded parts will not be recorded).
- When you press [OK] to start copy, the tape is automatically fast-forwarded to the end and then fast-rewound to the beginning before the copying is actually started. It may take time to start copy. If the remaining capacity of the disc is insufficient, the copying will be stopped in the middle.
- The recording is divided into titles every time the tape index signals are detected.

When “Time Setting” is set to “On” in step 6 (⇒ left):

- The recording mode is automatically determined by estimating the remaining capacity of the disc for copying of the contents equivalent to the recording time set from the start point of the copying on the video cassette (unrecorded parts will also be recorded).
- The recording is not divided into titles.

Copying Titles or Playlists

Copying Titles or Playlists (DVD → VHS)

RAM -RW(VR) +RW → VHS

- 1 Press [FUNCTION MENU].
- 2 Press [▲, ▼] to select “Copy”, then press [OK].
- 3 Press [▲, ▼] to select “Advanced Copy”, then press [OK].

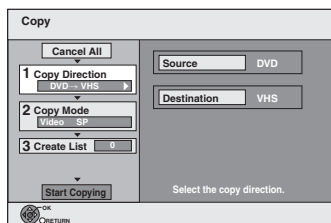

– If you are not going to change the registered list, press [▼] several times (⇒ step 7).

- 4 Set the copy direction.
 - If you are not going to change the copying direction, press [▼] (⇒ step 5).

- 1 Press [▲, ▼] to select “Copy Direction”, then press [▶].
- 2 Press [▲, ▼] to select “Source”, then press [OK].
- 3 Press [▲, ▼] to select “DVD”, then press [OK].
 - “Destination” is automatically set to “VHS”.
- 4 Press [◀] to confirm.

- 5 Set the recording mode.
 - If you are not going to change the recording mode, press [▼] (⇒ step 6).

- 1 Press [▲, ▼] to select “Copy Mode”, then press [▶].
 - “Format” is automatically set to “VIDEO”.
- 2 Press [▲, ▼] to select “Recording Mode”, then press [OK].
- 3 Press [▲, ▼] to select the mode, then press [OK].
- 4 Press [◀] to confirm.

- 6 Register titles and playlists for copy.
 - If you are going to copy a registered list without making any changes to it (⇒ step 7).

- 1 Press [▲, ▼] to select “Create List”, then press [▶].

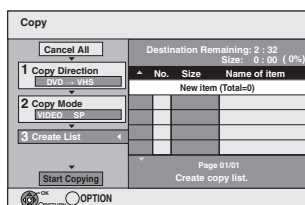

- 2 Press [▲, ▼] to select “New item”, then press [OK].
- 3 Press the “Red” button to select “VIDEO” or press the “Green” button to select “Playlists”.

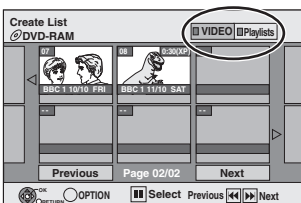

- 4 Press [▲, ▼, ◀, ▶] to select the title or playlist, then press [■].
 - A check mark is displayed. Repeat this step until you select all necessary items.
 - Press [■] again to cancel.
 - The items will be copied in the order of the copying list. If you want to specify the order, repeat selecting one item at a time.
 - When you switch between the “VIDEO” and “Playlists” tab, the check mark is cancelled.
 - To view other pages (⇒ 59, Tips)
- 5 Press [OK] to confirm.
 - To edit the copying list (⇒ right)
- 6 Press [◀] to confirm.

- 7 Press [▲, ▼] to select “Start Copying”, then press [OK].
- 8 Press [◀] to select “Yes”, then press [OK] to start copying.

Edit the copying list

Select the item in step 6–8 (⇒ left)
Press [OPTION].

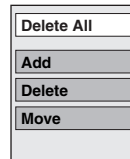

Delete All	Delete all items registered on the copying list. 1. Press [▲, ▼] to select “Delete All”, then press [OK]. 2. Press [◀] to select “Yes”, then press [OK].
Add	Add new items to the copying list. 1. Press [▲, ▼] to select “Add”, then press [OK]. 2. Press [▲, ▼, ◀, ▶] to select the title or playlist, then press [■]. A check mark is displayed. Repeat this step until you select all necessary items. • Press [■] again to cancel. 3. Press [OK].
Delete	Delete the selected items. 1. Press [▲, ▼] to select “Delete”, then press [OK]. 2. Press [◀] to select “Yes”, then press [OK].
Move	Move selected items or change the order of items on the copying list. 1. Press [▲, ▼] to select “Move”, then press [OK]. 2. Press [▲, ▼] to select the destination, then press [OK].

Cancel all registered copying setting and lists

After performing steps 1–3 (⇒ left)

- 4 Press [▲, ▼] to select “Cancel All”, then press [OK].
- 5 Press [◀, ▶] to select “Yes”, then press [OK].

- The settings and lists may be cancelled in the following situations.
 - When a title or a playlist has been recorded or deleted at the copy source
 - When steps have been taken, for instance, to turn off the unit, open the tray, change the copy direction, etc.

Copying list icons and functions

The following icons give more information about copy restrictions of the title.



Title with "One time only recording" restriction
(⇒ 27, Copy-once recording)



Title or playlist contains still picture(s)
• Still picture(s) cannot be copied.



(NTSC) Title or playlist recorded using a different encoding system from that of the TV system currently selected on the unit.



(PAL) Titles and playlists displaying these marks cannot be selected.

Data size of each registered item

No.	Size	Name of Item
New Item		(Total=0)

Page 01/01
Create copy list.

Size:

Data size recorded to the copy destination

- The total data size will change according to the recording mode.
- The total data size shown may be larger than the sum of the data sizes for each registered item, because of data management information being written to the copy destination, etc.

Tips

To view other pages

Press [▲, ▼, ◀, ▶] to select "Previous" or "Next", then press [OK].

– You can also press [◀◀, ▶▶] to show other pages.

To stop copying

Press and hold [RETURN ↵] for 3 seconds.
(You cannot stop while finalising)

To return to the previous screen

Press [RETURN ↵].

Copying a finalised DVD-R, DVD-R DL, DVD-RW (DVD-Video format), +R and +R DL

DVD-V → VHS

You can copy the content of finalised DVD-R, DVD-R DL, DVD-RW (DVD-Video format), +R, and +R DL to the VHS.

While playing a disc, the content being played is copied to the VHS according to the set time

- **Operations and on-screen displays during copy are also recorded.**
- Almost all DVD-Video on sale have been treated to prevent illegal copying, and cannot be copied.

Preparation:

- Insert the finalised disc (⇒ 7).
- Insert a video cassette that you can use for copying (⇒ 7).

After performing steps ①–⑤ ("Format" is automatically set to "DVD-Video") (⇒ 58, Copying Titles or Playlists (DVD → VHS))

⑥ Set "Copy Time".

– If you are not going to change the setting (⇒ step ⑦).

- ① Press [▲, ▼] to select "Copy Time", then press [▶].
- ② Press [▲, ▼] to select "Time Setting", then press [OK].

– Setting the unit to copy all the content on the disc

- ③ Press [▲, ▼] to select "Off", then press [OK].
- ④ Press [◀] to confirm.

Copy will continue until there is not enough available recording space on the VHS.

– Setting the unit to copy according to the set time

- ③ Press [▲, ▼] to select "On", then press [OK].
- ④ Press [▲, ▼] to select "Copy Time", then press [OK].

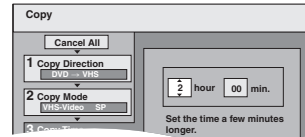

⑤ Press [◀, ▶] to select "hour" and "min.", then press [▲, ▼] to set the recording time.

⑥ Press [OK].

⑦ Press [◀] to confirm.

Copying to the VHS continues for the set time even after the content being played finishes.

– Set a few minutes longer than the source title, in order to include the operation time before play begins.

– You can also set the recording time with the numbered buttons.

⑦ Press [▲, ▼] to select "Start Copying", then press [OK].

⑧ Press [◀] to select "Yes", then press [OK] to start copying. The disc top menu is displayed.

– Disc play automatically begins from title 1 when "Title 1" is selected from the "Auto-Play Select" menu when finalising the disc (⇒ 65).

⑨ When the top menu is displayed

Press [▲, ▼, ◀, ▶] to select the title you want to start copying, then press [OK].

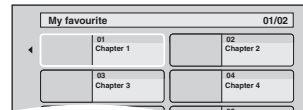

While playing in order, all the titles after the selected title are recorded until the set time. (After the last title on the disc has finished playing the top menu is recorded until the set time is reached.)

Tips

To return to the previous screen

Press [RETURN ↵].

To stop copying

Press [■].

You can also press and hold [RETURN ↵] for 3 seconds to stop copying.

- If stopped partway, copying will be up to that point.

Notes

- The screen on the right is recorded at the beginning.
- If play does not begin automatically or if the top menu does not display automatically, press [▶] (PLAY) to start.
- Even if you copy a high quality video/audio DVD, the original picture and audio quality cannot be exactly replicated.
- If you want to copy a title from a finalised DVD-RW (DVD Video Recording format), create a copy list and then copy (⇒ 58, Copying Titles or Playlists (DVD → VHS)).



Copying Still Pictures

RAM → RAM

After performing steps ①–③ (⇒ 58, Copying Titles or Playlists (DVD → VHS))

- ① Set “Source” and “Destination” to “DVD”. (⇒ step ④)

USB → RAM

- ① While stopped
Insert the USB memory (⇒ 7).
The menu is automatically displayed. (⇒ 42)
- ② Press [▲, ▼] to select “Picture (JPEG)”, then press [OK].
- ③ Press [▲, ▼] to select “Copy Selected Pictures (JPEG)”, then press [OK].
– “Source”, “Destination”, “Format” and “Recording Mode” are automatically set to “USB”, “DVD”, “PICTURE” and “High Speed” respectively.

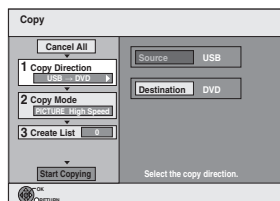

④ Register still pictures for copy.

- If you are going to copy a registered list without making any changes to it (⇒ step ⑤).
- You can register still pictures or still picture folders.
- Still pictures and folders cannot be registered on the same list.

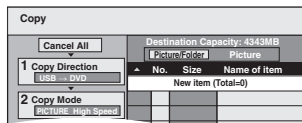

To register individual still pictures

- ① Press [▲, ▼] to select “Create List”, then press [▶].
- ② Press [▲, ▼] to select “New item”, then press [OK].
- ③ Press [▲, ▼, ◀, ▶] to select the still picture, then press [■].
A check mark is displayed. Repeat this step until you select all necessary items.
• Press [■] again to cancel.
• The items will be copied in the order of the copying list. If you want to specify the order, repeat selecting one item at a time.
– To show other pages (⇒ 61, Tips)
– To select another folder (⇒ 61, Tips)
- ④ Press [OK] to confirm.
– To edit the copying list (⇒ right)
- ⑤ Press [◀] to confirm.

To register on a folder by folder basis

- ① Press [▲, ▼] to select “Create List”, then press [▶].
- ② Press [▲, ▼] to select “Picture/Folder”, then press [OK].
- ③ Press [▲, ▼] to select “Folder”, then press [OK].
- ④ Press [▲, ▼] to select “New item”, then press [OK].
- ⑤ Press [▲, ▼] to select the folder, then press [■].
A check mark is displayed. Repeat this step until you select all necessary items.
• Press [■] again to cancel.
• The items will be copied in the order of the copying list. If you want to specify the order, repeat selecting one item at a time.
– To show other pages (⇒ 61, Tips)
- ⑥ Press [OK] to confirm.
- ⑦ Repeat steps ④–⑥ until you select all necessary folders.
– To edit the copying list (⇒ right)
- ⑧ Press [◀] to confirm.

- ⑤ Press [▲, ▼] to select “Start Copying”, then press [OK].
- ⑥ Press [◀] to select “Yes”, then press [OK] to start copying.

Edit the copying list

Select the item in step ④–④ (for a still picture) (⇒ left) or ④–⑥ (for a folder) (⇒ left)

Press [OPTION].

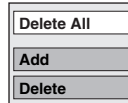

Delete All	Delete all items registered on the copying list. 1. Press [▲, ▼] to select “Delete All”, then press [OK]. 2. Press [◀] to select “Yes”, then press [OK].
Add	Add new items to the copying list. 1. Press [▲, ▼] to select “Add”, then press [OK]. 2. Press [▲, ▼, ◀, ▶] to select the still picture or folder to be added, then press [■]. A check mark is displayed. Repeat this step until you select all necessary items. • Press [■] again to cancel. 3. Press [OK].
Delete	Delete the selected items. 1. Press [▲, ▼] to select “Delete”, then press [OK]. 2. Press [◀] to select “Yes”, then press [OK].

Cancel all registered copying setting and lists

After performing steps ①–③ (⇒ left)

- ④ Press [▲, ▼] to select “Cancel All”, then press [OK].
 - ⑤ Press [◀] to select “Yes”, then press [OK].
- The settings and lists may be cancelled in the following situations.
– When a still picture has been recorded or deleted at the copy source
– When steps have been taken, for instance, to turn off the unit, remove the USB memory, open the tray, etc.

Tips

To stop copying

Press and hold [RETURN ↵] for 3 seconds.

To return to the previous screen

Press [RETURN ↵].

To view other pages

Press [▲, ▼, ◀, ▶] to select “Previous” or “Next”, then press [OK].

– You can also press [◀◀, ▶▶] to view other pages.

To select another folder

After performing step ④–② (⇒ 60, To register individual still pictures)

① Press [▲, ▼, ◀, ▶] to select “Folder”, then press [OK].

② Press [▲, ▼] to select the folder, then press [OK].

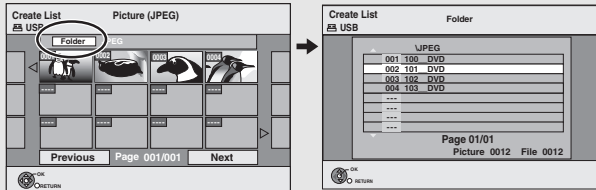

You can also select folders with the numbered buttons.

e.g., 5: [0] ⇒ [0] ⇒ [5]
15: [0] ⇒ [1] ⇒ [5]
115: [1] ⇒ [1] ⇒ [5]

The still pictures of different folders cannot be registered on the same list.

Notes

- Copy Mode is fixed at “PICTURE High Speed”.
- The structure of folders on the USB memory may not be the same at the copy destination.
- The sequence in which the still pictures are registered on the copy list may not be the same at the copy destination.
- If the space on the destination drive runs out or the number of files/folders to be copied exceeds the maximum (⇒ 28), copying will stop partway through.
- You cannot copy the information about the picture rotation.

Setting On-Screen Display

Accessing the On-Screen Display

When playing discs (except for JPEG discs), you can display and set the options including disc audio, subtitle, image quality, sound effect, Repeat Play, etc. In addition, when receiving the multi-audio broadcast, you can change the audio settings. Menu options will differ based on disc type and contents.

1 Press [DISPLAY].

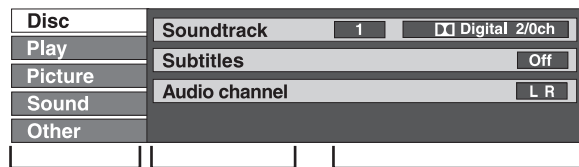

- 2 Press [▲, ▼] to select a menu, then press [▶].
- 3 Press [▲, ▼] to select an item, then press [▶].
- 4 Press [▲, ▼] to select a setting.

Follow the on-screen prompts to change individual settings.

Notes

- Some settings may not be changeable, based on the unit's current activity (playing, stopped, etc.) and disc contents.
- When the VHS drive is selected, you can only set "Copy NR", "DVB Multi Audio" and "Position".

Tips

To exit the on-screen display
Press [DISPLAY].

Disc Menu

RAM -R -R DL -RW(V) +R +R DL +RW DVD-V -RW(VR) VCD
You can change the settings of disc audio, subtitle, etc.

Soundtrack

RAM -R -R DL -RW(V) +R +R DL +RW -RW(VR)
The disc's audio attributes appear (⇒ below, Audio attributes).

DVD-V

Select the audio and language (⇒ below, Audio attributes, Soundtrack/Subtitle language).

VCD (SVCD)

Select the soundtrack number.

- Soundtrack numbers are displayed even when there is only one audio type.

Subtitles

RAM -R -R DL -RW(V) +R +R DL +RW -RW(VR)
(Only discs that contain subtitle on/off information)

Turn the subtitle on/off.

- Subtitle on/off information cannot be recorded using this unit.

DVD-V

Turn the subtitle on/off and select the language (⇒ below, Soundtrack/Subtitle language).

VCD (SVCD)

Turn the subtitle on/off and select the subtitle number.

- Subtitle numbers are displayed even if there are not multiple subtitles.

Audio channel

RAM -RW(VR) VCD

Change audio during playback.

LR / L / R

Angle

DVD-V

Change the number to select an angle.

PBC (Playback control ⇒ 92) VCD

Indicates whether menu play (playback control) is on or off.

Soundtrack/Subtitle language

ENG: English	DAN: Danish	THA: Thai
FRA: French	POR: Portuguese	POL: Polish
DEU: German	RUS: Russian	CES: Czech
ITA: Italian	JPN: Japanese	SLK: Slovak
ESP: Spanish	CHI: Chinese	HUN: Hungarian
NLD: Dutch	KOR: Korean	FIN: Finnish
SVE: Swedish	MAL: Malay	*: Others
NOR: Norwegian	VIE: Vietnamese	

Audio attributes

LPCM/Digital/DTS/MPEG:	Signal type
k (kHz):	Sampling frequency
b (bit):	Number of bits
ch (channel):	Number of channels

Notes

- You cannot make a change when there is no recording.
- Some discs allow changes to soundtracks, subtitles, and angles only by using the disc's menus (⇒ 20).

Play Menu

RAM -R -R DL -RW(V) +R +R DL +RW DVD-V -RW(VR) CD
VCD

Repeat Play

This function works only when the elapsed play time is displayed.

Select the item for repeat play. Depending on the disc, the items that can be selected will differ.

Select "Off" to cancel.

Picture Menu

RAM -R -R DL -RW(V) +R +R DL +RW DVD-V -RW(VR)

You can change the noise reduction setting when playing discs or of images from the connected device.

Playback NR

Reduces noise and picture degradation while playing.

- On: Reduces noise and picture degradation.
- Off: Video is played back as it is.

Copy NR

Reduces the noise while recording.

- Automatic: Noise reduction only works on picture input from a video tape.
- On: Noise reduction works for any video input.
- Off: Noise reduction is off. Select when you want to record input as is.

Sound Menu

You can change the settings of audio when receiving the multi-audio broadcast, and also change the settings of sound effect when playing discs.

DVB Multi Audio

[MPEG Audio only]

If more than one audio channel is output, you can set the desired channel before recording.

- DVB Multi Audio cannot be selected during playback or recording.
- Depending on the broadcast, the items that can be selected will differ.

English 1/ English 2

Dialogue Enhancer

RAM -R -R DL -RW(V) +R +R DL +RW DVD-V -RW(VR)
(Dolby Digital, 3-channel or over only, including a centre channel)

When "On", the volume of the centre channel is raised to make dialogue easier to hear.

Other Menu

Position

Change where this menu screen appears on your TV.

DVD Management

You can manage discs through formatting, finalising and other operations.

Accessing the Management Menus

Preparation:

- **RAM** Release protection (⇒ below, "Setting Protection").
- Insert a disc.

With the unit stopped

- 1 Press [DRIVE SELECT] to select the DVD drive.
- 2 Press [FUNCTION MENU].
- 3 Press [▲, ▼] to select "Others", then press [OK].

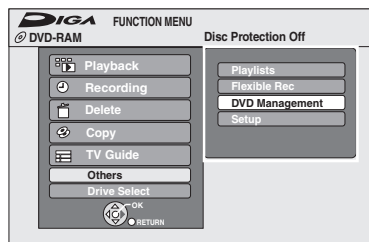

- 4 Press [▲, ▼] to select "DVD Management", then press [OK].

Tips

To return to the previous screen

Press [RETURN ↵].

To exit the screen

Press [EXIT].

Naming Discs

RAM -R -R DL -RW(V) +R +R DL +RW

You can give a name for the disc.

Perform preparation steps 1–4 of "Accessing the Management Menus" (⇒ above).

- 5 Press [▲, ▼] to select "Disc Name", then press [OK].
Entering Text (⇒ 49).

Tips

- **-R -R DL -RW(V) +R +R DL** With a finalised disc, the name is displayed on the Top Menu.
- **+RW** The disc name is displayed only if you play the disc on other equipment after creating top menu.

Setting Protection

RAM

Use to prevent accidental erasure of disc.

Perform preparation steps 1–4 of "Accessing the Management Menus" (⇒ above).

- 5 Press [▲, ▼] to select "Disc Protection", then press [OK].
- 6 Press [◀] to select "Yes", then press [OK].

Deleting All Titles

You can delete all titles on the single-sided DVD-RAM at once.

Important: Once deleted, contents cannot be recovered.

RAM

Perform preparation steps 1–4 of "Accessing the Management Menus" (⇒ left).

- 5 Press [▲, ▼] to select "Delete all titles", then press [OK].
- 6 Press [◀] to select "Yes", then press [OK].
- 7 Press [◀] to select "Start", then press [OK].
– A message appears when deleting is finished.
- 8 Press [OK] to complete.

Notes

- Deleting does not work if one or more titles are protected.
- Still picture data (JPEG) or computer data cannot be deleted.

Formatting Discs

RAM -RW(V) +RW -RW(VR)

+R +R DL (New disc only)

Formatting is the process of making media such as DVD-RAM recordable on recording equipment.

You can record or edit after formatting the finalised DVD-RW.

Important: Once formatted, contents cannot be recovered.

Perform preparation steps 1–4 of "Accessing the Management Menus" (⇒ left).

- 5 Press [▲, ▼] to select "Format Disc", then press [OK].
- 6 Press [◀] to select "Yes", then press [OK].
- 7 Press [◀] to select "Start", then press [OK].
– Formatting starts (**RAM** may take up to a maximum of 70 minutes).
– A message appears when formatting is finished.
- 8 Press [OK] to complete.

Notes

- Do not disconnect the AC mains lead while formatting. This can render the disc unusable.
- When a disc has been formatted using this unit, it may not be possible to use it on any other equipment.
- **-R -R DL CD** Formatting cannot be performed.
- **-RW(V) -RW(VR)** You can format only as DVD-Video format on this unit.
- The message "Unable to format" appears when trying to format discs the unit cannot use.

Selecting Whether to Show the Top Menu First —Auto-Play Select

-R -R DL -RW(V) +R +R DL +RW

Before finalising a disc, select whether the top menu shows after finalising.

Perform preparation steps 1–4 of "Accessing the Management Menus" (⇒ left).

- 5 Press [▲, ▼] to select "Auto-Play Select", then press [OK].
- 6 Press [▲, ▼] to select "Top Menu" or "Title 1", then press [OK].
 - Top Menu:
The Top Menu appears first.
 - Title 1:
The disc content is played without displaying the Top Menu.

Finalising

-R -R DL -RW(V) +R +R DL

You can play these discs on compatible DVD players by finalising it on the unit, effectively making it into DVD-Video that complies with DVD-Video standards. The menu you create with the unit can also be used on most DVD players.

Perform preparation steps ①–④ of “Accessing the Management Menus” (⇒ 64).

- ⑤ Press [**▲**, **▼**] to select “Finalise”, then press [OK].
- ⑥ Press [**◀**] to select “Yes”, then press [OK].
- ⑦ Press [**◀**] to select “Start”, then press [OK].
 - Finalising starts and cannot be cancelled (may take up to 15 minutes) (**-R DL +R DL** up to 60 minutes)
 - A message appears when finalising is finished.
- ⑧ Press [OK] to complete.

Notes

- Do not disconnect the AC mains lead while finalising. This can render the disc unusable.
 - When finalising a high-speed recording compatible disc, it may take longer than displayed on the confirmation screen (approximately 4 times longer).
 - After finalising
 - **-R -R DL +R +R DL** The disc becomes play-only and you can no longer record or edit it.
 - **-RW(V)** You can record and edit the disc after formatting although it becomes play-only after finalising.
 - The disc finalised on the unit may not be playable on other players depending on the condition of the recording.
 - There is a pause of several seconds between titles and chapters during playback.
 - Chapters are created automatically (**-R -R DL -RW(V)** about 5-minute chapters* **+R +R DL** about 8-minute chapters*).
- * This time varies greatly depending on the condition and mode of recording.

Tips

- After you have finished recording or copying and try to eject the disc, a screen asking if you want to finalise the disc appears (⇒ 29).

Create Top Menu

+RW

+RW discs contain no Top Menu data. Top Menu is a convenient function. We recommend you create the menu before playing a +RW disc on other equipment.

Perform preparation steps ①–④ of “Accessing the Management Menus” (⇒ 64).

- ⑤ Press [**▲**, **▼**] to select “Create Top Menu”, then press [OK].
- ⑥ Press [**◀**] to select “Yes”, then press [OK].
- ⑦ Press [**◀**] to select “Start”, then press [OK].
 - “Create Top Menu” cannot be cancelled once started.
 - “Create Top Menu” takes a few minutes.
- ⑧ Press [OK] to complete.

Notes

- Recording or editing on the disc may delete the Top Menu. In that case, create the Top Menu again.
- You cannot use the Top Menu for playing on this unit.

Enabling the Second Layer on DL (Dual- or Double-Layer on Single Side) Discs to be Recordable

-R DL +R DL

DVD-R DL and +R DL discs have two layers of recording surface on one side. As this unit does not offer seamless recording on two layers, recording stops when space on the first layer becomes full. You must close the first layer to start recording on the second layer. Closing makes the first layer unavailable for recording (editing is still possible).

Perform preparation steps ①–④ of “Accessing the Management Menus” (⇒ 64).

- ⑤ Press [**▲**, **▼**] to select “Close First Layer”, then press [OK].
- ⑥ Press [**◀**] to select “Yes”, then press [OK].
- ⑦ Press [**◀**] to select “Start”, then press [OK].
- ⑧ Press [OK] to complete.

Notes

- The first layer cannot be closed when there is no recording on it.
- Closing cannot be cancelled once started.
- Do not disconnect the AC mains lead while closing the layer. This can render the disc unusable.
- Closing takes several minutes, up to a maximum of 30 minutes, depending on the remaining space on the first layer.

Tips

- You can confirm the remaining recording time on the layer in the DVD Management screen.

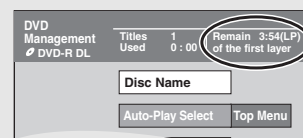

Setup Menu

You can change the unit's settings using Setup menu.

Accessing the Setup Menu

With the unit stopped

- 1 Press [FUNCTION MENU].
- 2 Press [▲, ▼] to select "Others" and press [OK].

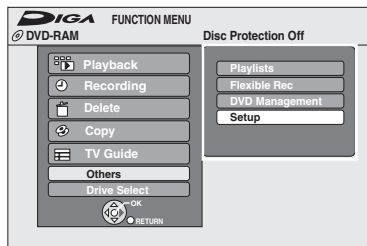

- 3 Press [▲, ▼] to select "Setup", then press [OK].
- 4 Press [▲, ▼] to select a menu, then press [▶] to go to the item list.

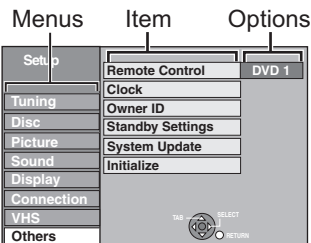

- 5 Press [▲, ▼] to select an item to change, then press [OK].
- 6 Press [▲, ▼] to select the option, then press [OK].

Notes

- Changed settings remain intact even when switching the unit to standby mode.

Tips

To return to the previous screen

Press [RETURN ↵]. Even if you have changed an option, the change is not activated until you press [OK].

To exit the screen

Press [EXIT].

Channel Settings

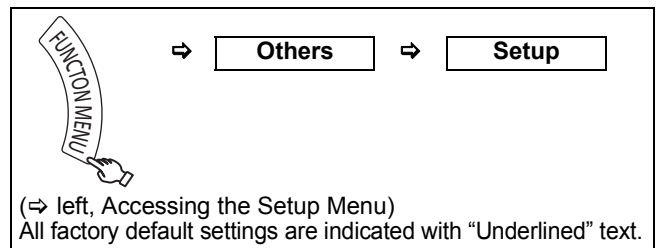

Tuning

▲, ▼ select "Tuning" ⇒ ▶ ⇒ ▲, ▼ select item ⇒ [OK]

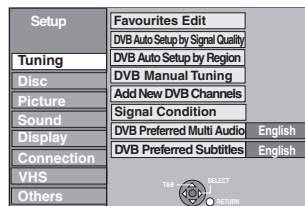

Favourites Edit

You can create four Favourites of channels for making viewing and recording easier. Editing these Favourites does not affect the channel setting itself.

- Timer recording may not work correctly if you edit the Favourites during timer recording standby.
- Channel numbers cannot be changed, due to broadcast restrictions.

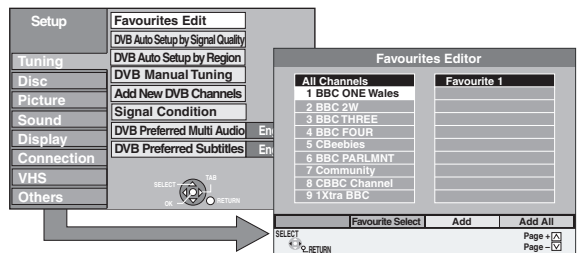

To select the Favourite
Press the "Green" button.

To add channels to a Favourite

- 1 Press [▲, ▼] to select the channel in the "All Channels" column to add, then press the "Yellow" button.
 - Repeat this step to add other channels.
 - Press the "Blue" button to add all the available channels to the Favourite. (Only when no channels have been added to the Favourite.)
- 2 Press [OK] to save the Favourite.

To change the order of channels of a Favourite

- 1 Press [▶]*.
- 2 Press [▲, ▼] to select the channel in the "Favourite" column to move, then press the "Green" button.
- 3 Press [▲, ▼] to select the new position of the channel, then press the "Green" button.
 - Repeat the steps 2–3 to move other channels.
- 4 Press [OK] to save the Favourite.

To delete channels on a Favourite

- 1 Press [▶]*.
- 2 Press [▲, ▼] to select the channel in the "Favourite" column, then press the "Yellow" button.
 - Repeat this step to delete other channels.
 - Press the "Blue" button to delete all the channels from the Favourite.
- 3 Press [OK] to save the Favourite.

Deleting a channel from a Favourite does not affect the channel itself.

You can still select the channel from the "All Channels" column.

To change the name of a Favourite in the "Favourite" column

- 1 Press [▶]*.
- 2 Press the "Red" button. (⇒ 49, Entering Text)

* When the station name of the "All Channels" column is highlighted

Tips

To browse through the list
Press [▲ ▼ CH].

DVB Auto Setup by Signal Quality

DVB Auto Setup by Region

You can restart auto channel setting for digital terrestrial channels if the setup (⇒ 13) fails for some reason.

If you want to set the channel list best suited to your region, select "DVB Auto Setup by Region". Follow the on-screen instructions to select the region you live in.

However, if you perform "DVB Auto Setup by Signal Quality" or "DVB Auto Setup by Region", all channel settings, Favourites and all the timer recording programmes are deleted. (All the settings except for the ratings level, ratings PIN, Owner ID, Clock and remote control code, etc. return to the factory preset.)

When the confirmation screen appears

Press [◀] to select "Yes", then press [OK].

Tips

- You can also use the following method to restart DVB Auto Setup by Signal Quality. When the unit is turned on and stopped, press and hold [CH ▲] and [▼ CH] on the main unit simultaneously for about 5 seconds. – Auto-Setup screen appears.

DVB Manual Tuning

You can set channels manually if the "DVB Auto Setup by Signal Quality" could not be completed successfully.

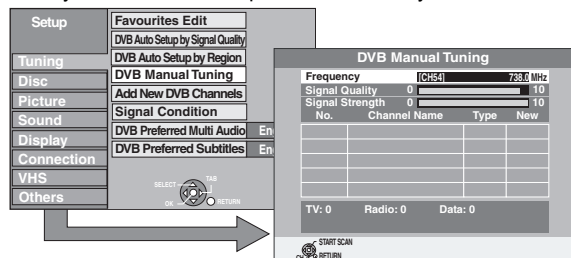

- Press [▲, ▼] to select the channel you want to set.
 - Select the channel by checking the signal strength and signal quality displays. [Refer to "Signal Condition" (⇒ right) for signal strength and signal quality.]

- Press [OK] to start scan. The set channel is displayed in the table.
 - Repeat steps 1–2 to tune other channels.

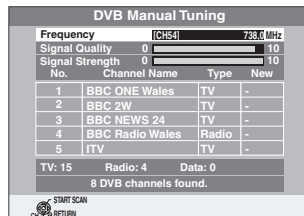

- Press [EXIT], then press [^ v CH] to check that applicable channels have been selected.

Add New DVB Channels

You can search for newly added digital terrestrial channels to receive.

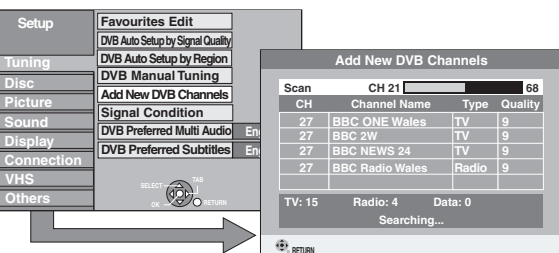

- The unit starts searching for newly available digital terrestrial channels. This takes about 5 minutes.
- The bar over the table shows you the search progress. At the end of the search, the number of found new digital stations appears.
- "No new DVB channels found." is displayed when no new channels can be found.

Press [OK] to save the newly found channels.

Tips

- To cancel in middle Press [RETURN ↵]. The channels found before stopping are not saved.

Signal Condition

You can check the quality and strength of digital broadcast signals.

When "Signal Condition" is displayed in grey and cannot be selected:

- Press [EXIT] to exit the screen.
- Press [^ v CH] to select a digital channel. "D" appears on the unit's display.
- Display the Setup menu again.

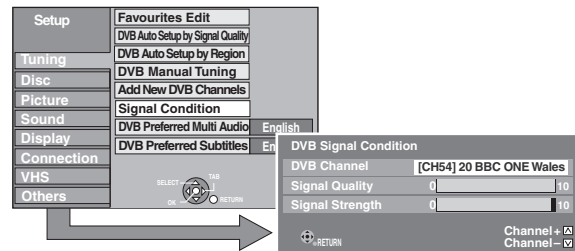

The quality and strength of the signal are shown. Press [^ v CH] to select the channel.

Signal Quality

Below 2 (display red)	The signal quality is so poor that there may be interference in the pictures and sound.
2–5 (display orange)	The signal quality is basically adequate, but brief interference in the pictures and sound is possible in isolated case.
Over 5 (display green)	Optimum picture and sound quality.

Signal Strength

The display for signal strength is grey. "0" means signal strength 0%, "10" means signal strength 100%.

- If the signal is too strong, the display will change from grey to red. Reduce the signal amplification at your aerial.
- When the signal is weak:
 - check that the aerial is correctly positioned.
 - adjust the aerial reception with "DVB Manual Tuning" in the Setup menu (⇒ left).
 - check that the current digital broadcast channel is correctly broadcasting.
 - check that your aerial is capable of receiving DVB broadcasts.

DVB Preferred Multi Audio

Choose the audio language for digital broadcast.

If the selected language is not available, then the original language will be selected.

[English] [Welsh] [Gaelic]

DVB Preferred Subtitles

Choose the subtitle language for digital broadcast.

If the selected language is not available, then the original language will be selected.

[English] [Welsh] [Gaelic]

[English for hearing impaired]

[Welsh for hearing impaired]

[Gaelic for hearing impaired]

Playback/Recording and Picture Settings

⇒ **Others** ⇒ **Setup**

(⇒ 66, Accessing the Setup Menu)
All factory default settings are indicated with "Underlined>" text.

Disc

▲, ▼ select "Disc" ⇒ ► ⇒ ▲, ▼ select item ⇒

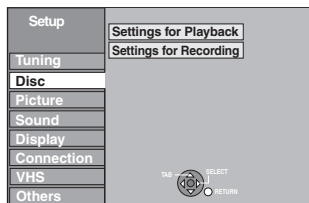

Settings for Playback

Press [OK] to show the following settings.

Ratings

Set a ratings level to limit DVD-Video play. Follow the on-screen instructions. Enter a 4-digit PIN with the numbered buttons when the PIN screen is shown. Do not forget your PIN.

- Setting ratings (When level 8 is selected)

[8 No Limit] All DVD-Video can be played.
[1] to [7] Prohibits play of DVD-Video with corresponding ratings recorded on them.

[0 Lock All] Prohibits play of all DVD-Video.

- Changing settings (When level 0 to 7 is selected)

[Unlock Recorder] [Change PIN]
[Change Level] [Temporary Unlock]

Soundtrack

[English] [German] [French] [Italian]
[Spanish] [Original] [Other*****]

Subtitles

[Automatic] [English] [German] [French]
[Italian] [Spanish] [Other*****]

Menus

[English] [German] [French] [Italian]
[Spanish] [Other*****]

Notes

DVD-V Choose the language for audio, subtitles and disc menus. If a language which is not recorded is selected, or if languages are already fixed on the disc, the language set as the default on the disc will be played instead.

[Original] The original language of each disc will be selected.

[Other*****] This is the language code setting. Input a code number with the numbered buttons (⇒ 82, Language code list).

[Automatic] If the language selected for "Soundtrack" is not available, subtitles of that language will automatically appear if available on the disc.

Settings for Recording

- Press [OK] to show the following settings.

Recording time in EP mode

Select the maximum number of hours for recording in EP mode.

[EP (6 hours)] You can record for 6 hours on an unused 4.7 GB disc.

[EP (8 hours)] You can record for 8 hours on an unused 4.7 GB disc.

Chapter Creation

Set the automatic Chapter Creation method. (⇒ 52)

[Automatic] [5 minutes]

[Off] No chapter start points are set.

Picture

▲, ▼ select "Picture" ⇒ ► ⇒ ▲, ▼ select item ⇒

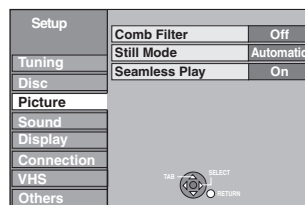

Comb Filter

Select the picture sharpness when recording.

The setting is fixed with "On" if you set "TV System" to "NTSC". (⇒ 70)

[On] Select it to record clear picture when "Off" is selected, the picture is not clear.

[Off] Normally, use this setting.

Still Mode

Select the type of picture shown when you pause play (⇒ 92, Frame and Field).

[Automatic]

[Field] Select if jittering occurs when "Automatic" is selected.

[Frame] Select if you cannot see small text or fine patterns clearly when "Automatic" is selected.

Seamless Play

Select the play mode between playlist chapter segments and partially deleted titles.

[On] The chapters in playlists are played seamlessly. This does not work when there are several audio types included on the playlist and when using Quick View (⇒ 38). Additionally, the positioning of chapter segments may change slightly.

[Off] The points where chapters in playlists change are played accurately, but the picture may freeze for a moment.

Sound and Display Settings

(⇒ 66, Accessing the Setup Menu)
All factory default settings are indicated with "Underlined>" text.

Sound

▲, ▼ select "Sound" ⇒ ▶ ⇒ ▲, ▼ select item ⇒

Setup	Dynamic Range Compression	Off
Tuning	Digital Audio Output	
Disc	Audio Mode for XP Recording	Dolby Digital
Picture		
Sound		
Display		
Connection		
VHS		
Others		

Dynamic Range Compression

DVD-V (Dolby Digital only)
Change the dynamic range (⇒ 92) for easier listening in low volume.
[On] Off

Digital Audio Output

Change the settings when you have connected equipment through the unit's Digital Audio Out terminal (⇒ 76).
Press [OK] to show the following settings.

PCM Down Conversion

Select how to output audio with a sampling frequency of 96kHz. Signals are converted to 48 kHz despite the above settings if the signals have a sampling frequency of over 96 kHz, or the disc has copy protection.

[On] Signals are converted to 48 kHz. (Choose when the connected equipment cannot process signals with sampling frequency of 96 kHz.)

[Off] Signals are output as 96 kHz. (Choose when the connected equipment can process signals with sampling frequency of 96 kHz.)

Dolby Digital*

Choose whether to output by "Bitstream", which processes Dolby Digital signals on other connected equipment, or to convert the signals to "PCM" (2ch) on the unit before output.

[Bitstream] When connected to equipment with a built-in Dolby Digital decoder.

[PCM] When connected to equipment without a built-in Dolby Digital decoder.

DTS*

Choose whether to output by "Bitstream", which processes DTS signals on other connected equipment or to convert the signals to "PCM" (2ch) on the unit before output.

[Bitstream] When connected to equipment with a built-in DTS decoder.

[PCM] When connected to equipment without a built-in DTS decoder.

MPEG*

Choose whether to output by "Bitstream", which processes MPEG audio signals on other connected equipment or to convert the signals to "PCM" (2ch) on the unit before output.

[Bitstream] When connected to equipment with a built-in MPEG decoder.

[PCM] When connected to equipment without a built-in MPEG decoder.

Audio Mode for XP Recording

Choose the audio type when recording or copying with XP mode.

[Dolby Digital] (⇒ 92) [LPCM] (⇒ 92)

- The picture quality of LPCM recordings may be lower than that of normal XP mode recordings.
- The audio recording becomes Dolby Digital even if you selected LPCM when using a recording mode other than XP.

* Incorrect settings can cause noise to be output which can be harmful to your ears and speakers, and audio will not be recorded properly on media such as mini discs.
Refer to the operating instructions for connected devices to verify whether or not they can decode each of the audio formats.

Display

▲, ▼ select "Display" ⇒ ▶ ⇒ ▲, ▼ select item ⇒

Setup	On-Screen Messages	5 sec.
Tuning	Unit's Display	Bright
Disc	New Channel Message	Automatic
Picture	Screen Saver	On
Sound	FUNCTION MENU Display	Off
Display		
Connection		
VHS		
Others		

On-Screen Messages

Choose the approximate time until the digital channel information screen (⇒ 48) disappears automatically.

The length of time the Control Panel (⇒ 47) is displayed can also be changed, but "Off" does not work.

[Off] The digital channel information is not displayed.
[3 sec.] [5 sec.] [7 sec.] [10 sec.]

Unit's Display

Changes the brightness of the unit's display.

Regardless of the setting, when "Power Save in Standby" (⇒ 72) is activated and this unit is turned off, the unit's display is turned off.

[Bright] [Dim]

New Channel Message

Set whether to display the confirmation message when a DVB channel is added.

[Automatic] When a new DVB channel is added the unit will be informed automatically.

[Off] The Channel Messages are not shown.

Screen Saver

[On] When this unit is not operated for approximately 5 minutes while the screen is being displayed, the screen saver is displayed. To return to the previous screen, press [OK].

[Off]

FUNCTION MENU Display

[On] When the unit is turned on, the FUNCTION MENU will be displayed. (⇒ 45)

[Off]

Connection Settings

(⇒ 66, Accessing the Setup Menu)
All factory default settings are indicated with "Underlined>" text.

Connection

▲, ▼ select "Connection" ⇒ ► ⇒ ▲, ▼ select item ⇒

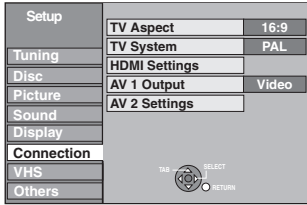

TV Aspect

This setting needs to be changed when connected to a 4:3 standard aspect TV.

[16:9] [4:3] [Letterbox]

Notes

Aspect 4:3/16:9

4:3

16:9

4:3 standard aspect television 16:9 widescreen television

- [16:9]: When connected to a 16:9 widescreen television.
- [4:3]: When connected to a 4:3 aspect television, side picture is trimmed for 16:9 picture (⇒ 92, Pan & Scan).
- [Letterbox]: When connected to a 4:3 aspect television, widescreen picture is shown in the letterbox style (⇒ 92).

TV System

Change this setting if you connect an NTSC television or to record NTSC video from another source.

1. Press [▲, ▼] to select the TV System, then press [OK].

[PAL]

- Select when connecting to a PAL or Multi-system television. Programmes recorded using NTSC are played as PAL 60.
- Select to record television programmes and PAL input from other equipment.

[NTSC]

- Select when connecting to an NTSC television. Television programmes cannot be recorded properly.
- Select to record NTSC input from other equipment.

The confirmation screen appears.

2. Press [◀] to select "Yes", then press [OK].

Tips

To change the setting all at once (PAL/NTSC)
While stopped, press and hold [■] and [▲ OPEN/CLOSE] on the main unit simultaneously for about 5 seconds.

Notes

- This unit cannot record NTSC signals to discs that already have PAL signal recordings.
- If "NTSC" has been selected, the TV Guide system cannot be used.
- During recording, timer recording standby or EXT LINK standby, this unit cannot play discs that do not match the "TV System" (PAL/NTSC) setting. Set "TV System" to match the discs before playing them. Change back the setting after playback of disc, otherwise recording may not be done properly.

HDMI Settings*1

• Press [OK] to show the following settings.

HDMI Video Format*2

You can only select items compatible with the connected equipment. If you are concerned about output picture quality, it may be improved by changing the setting.

- To enjoy High Quality Video up-converted to 1080p, you need to connect the unit directly to 1080p compatible HDTV. If this unit is connected to an HDTV through other equipment, it must also be 1080p compatible.

[576i/480i]	[576p/480p]	[720p]	[1080i]
[1080p]	When setting video output to "1080p", we recommend using High Speed HDMI Cables that have the HDMI logo (as shown on the cover) and are less than 5 meters to prevent video distortion etc.		
[Automatic]	Automatically selects the output resolution best suited to the connected television (1080p, 1080i, 720p, 576p/480p or 576i/480i).		

Aspect for 4:3 Video

To play a 4:3 title when connected with an HDMI cable, set how to show pictures on a 16:9 widescreen television. 4:3 picture from HDMI output will be slightly smaller than that from the other outputs, e.g. Scart, this is not a malfunction of the unit.

[4:3]	Picture output expands left or right.	
[16:9]	Picture is output as original aspect with side panels.	

Digital Audio Output

[HDMI and Optical]

[Optical Only] Select when this unit is connected to an amplifier with an optical digital audio cable (⇒ 76) and connected to a TV with an HDMI cable (⇒ 77) and you want to enjoy the highest quality of audio from discs.

VIERA Link

[On]

[Off] Select when you do not want to use "HDAVI Control".

VHS Settings

AV1 Output

Set according to the terminal of the connected TV.

[Video]

Select when a TV that can receive a composite signal is connected.

[RGB 1]

Select when a TV that can receive an RGB signal is connected. If you always would like to view the picture from the unit in RGB signal, select this mode. The TV screen will automatically switch to display the picture from the unit when the unit is turned on.

[RGB 2]

Select when a TV that can receive an RGB signal is connected. If you would like to switch to display the picture from the unit only when playback or viewing menus, select this mode.

- If this unit is connected with an HDMI cable, you cannot select "RGB 1" or "RGB 2".

AV2 Settings

Set to match the connected equipment.

- Press [OK] to show the following settings.

AV2 Input

Set to "RGB / Video" or "RGB" when receiving or recording RGB output from external equipment.

[RGB / Video] The unit automatically detects whether the input signal from the AV2 terminal is an RGB signal or other signals and makes settings.

[RGB]

[Video]

[S Video]

Ext Link

[Ext Link 1] When this unit is connected to a digital satellite receiver with a 21-spin Scart cable and this unit receives a control signal. Start and stop timings of recording are controlled by the control signal.

[Ext Link 2] When external equipment with a timer function is connected. Recording is continued while the image signal is being sent to the unit from the external equipment. Recording is stopped when the image signal is halted by turning the external equipment off.

*1 Depending on the connected equipment, some items may be shaded in grey on the display and cannot be selected, or you may not be able to change the settings.

*2 Choose the setting to suit your TV and preference.

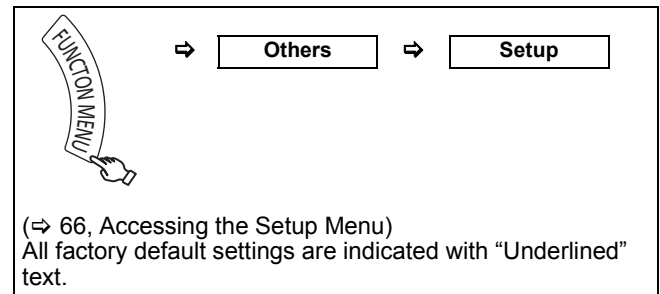

VHS

▲, ▼ select "VHS" ⇒ ▶ ⇒ ▲, ▼ select item ⇒

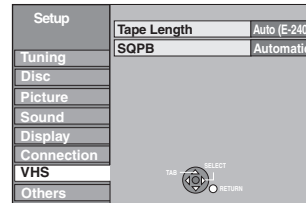

Tape Length

Set the length of the tape you are using so the unit can show the correct remaining time.

[Auto (E-240)] The unit automatically distinguishes E30, -60, -90, -120, -180, and -240 tapes.

[E-195] For E195 tape

[E-260] For E260 tape

[E-300] For E300 tape

SQPB

To play back video cassettes recorded in S-VHS format (SQPB; S-VHS Quasi Playback)

[Automatic] This unit automatically detects the format in which the recording was made and selects the same format for playback. However, picture distortion may occur. Therefore, set to "On" or "Off".

[On] Use this setting when playing back a cassette tape recorded in the S-VHS format.

[Off] Use this setting when playing back a cassette tape recorded in the VHS format only.

System Settings

(⇒ 66, Accessing the Setup Menu)
All factory default settings are indicated with “Underlined>” text.

Others

▲, ▼ select “Others” ⇒ ▶ ⇒ ▲, ▼ select item ⇒

Setup	Remote Control	DVD 1
Tuning	Clock	
Disc	Owner ID	
Picture	Standby Settings	
Sound	System Update	
Display	Initialize	
Connection		
VHS		
Others		

Remote Control (⇒ 82)

[DVD 1] [DVD 2] [DVD 3]

Clock (⇒ 14)

Owner ID (⇒ 13)

In order to prevent another person from using this unit if it is stolen, you can set a PIN number and input your personal information. Once the PIN number has been set, you cannot return to the factory preset. Make sure not to forget this.

●PIN number ●Name ●House No. ●Postcode

Standby Settings

●Press [OK] to show the following settings.

Power Save in Standby

- [On] It will go into the Power Save in Standby mode when the unit is in standby mode.
- [On Timer] “Power Save in Standby” is set to activate during the setting time period. (⇒ below)
- [Off] It is possible to start quickly from the standby mode. (Quick Start mode)

① Press [▲, ▼] to select “On Timer” and press [OK].

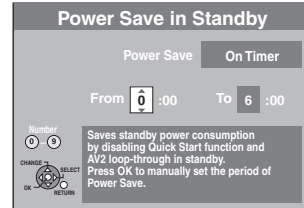

② Press [▲, ▼] to set the start time (hour).

③ Press [◀, ▶] to select the stop time and press [▲, ▼] to set the stop time (hour).

④ Press [OK] when you have finished the settings.

- You can also use the numbered buttons for setting.
- You can set start and stop time by the hour.
- If the clock has not been set, “Power Save in Standby” is activated at all hours.

Auto Standby

Set the time to automatically turn the unit off. After the unit has finished operating, the unit will be turned off once the set time has passed.

[30 minutes] [1 hour] [2 hours] [4 hours]

[6 hours]

[Off] The unit will not automatically turn off.

Auto Standby after OTR

[On] This unit is turned to standby mode when this unit is not operated for approximately 5 minutes after completing One Touch Recording (⇒ 29).

[Off]

Auto Standby after Copy

[On] This unit is turned to standby mode when this unit is not operated for approximately 5 minutes after completing copy (⇒ 57-61).

[Off]

RF OUT (Aerial Signal)

[On] Broadcast signals are output from this unit. TV can receive broadcast signals even if this unit is in standby mode when connecting TV with this unit using the RF cable (⇒ 10).

[Off] Press [◀, ▶] to select “Yes” when the confirmation message is displayed. Broadcast signals are not output from this unit to reduce standby power consumption.

- Power consumption is lowered additionally when “Power Save in Standby” is activated.
- If this unit turns into standby mode when connecting TV with this unit using the RF cable, proper broadcast images do not appear on TV.

System Update

In order to update this unit, the TV Guide download, and support system changes made by broadcasts, this unit periodically performs software updates.

- Press [OK] to show the following settings.
- Update data and TV Guide download information are sent by an unscheduled digital broadcast. In order to receive these updates, you must be able to receive digital broadcasts.
- An update will take approximately 60 minutes. While the update is in progress, "SW-DL" appears on the unit's display. You cannot operate the unit until the update is complete. Removing the AC mains lead while the update is in progress may damage the unit.
- TV Guide download will take approximately 30 minutes. While the TV Guide download is in progress, "GUIDE" appears on the unit's display. The TV Guide download can be interrupted by switching on the unit.
- To avoid hearing the startup sound of System Update for the unit, perform the following steps.
 - Select the time for Software Update (⇒ below, TV Guide/Software search period).
 - Set "TV Guide Download in Standby" and "Software Update in Standby" (⇒ below) to "Off", and update manually (⇒ below, Software Update Search Now).

TV Guide Download in Standby

[On] When the unit is turned off, TV Guide data is downloaded automatically.

[Off]

Software Update in Standby

[On] You can perform the unit updates automatically when the unit is turned off.

[Off]

TV Guide/Software search period

Selects the time to automatically perform TV Guide download and updates when the unit is turned off. This can only be set when "TV Guide Download in Standby" or "Software Update in Standby" is set to "On".

- If there is a programmed recording set for the time you have selected, the programmed recording will be given priority.

When the GUIDE Plus+ system is not available

[Automatic] The unit will give priority to searching for update data at midnight.

[02:00–06:00] [06:00–10:00] [10:00–14:00]

[14:00–18:00] [18:00–22:00] [22:00–02:00]

When the GUIDE Plus+ system is available

[Automatic]

[Daytime] Updating is executed during daytime (06:00–22:00).

Software Update Search Now

Start the search for new software manually. A new software version is announced by a message. Do not turn this unit off during the update. This could result in the loss of data. A message shows that the update has finished.

- If applicable update data is found, press [◀, ▶] to select "Yes", then press [OK].

GUIDE Plus+ System Information

You can check the condition of GUIDE Plus+ system of this unit.

Post Code

You can input the postal code which is necessary to download area specific information of GUIDE Plus+ system.

Initialize

- Press [OK] to show the following settings.

Shipping Condition

This returns Setup menus to default settings, except for the ratings level, ratings PIN, Slideshow Settings, Owner ID and clock settings, etc.

[Yes] [No]

- The timer recording programmes are also cancelled.

Default Settings

This returns Setup menus to default settings, except for the tuning settings, clock settings, disc language settings, ratings level, ratings PIN, Slideshow Settings, Owner ID and remote control code, etc.

[Yes] [No]

- The timer recording programmes are also cancelled.

Other Settings

Child Lock

The Child Lock deactivates all buttons on the unit and remote control. Use it to prevent other people from operating the unit.

Press and hold [OK] and [RETURN ↵] at the same time until "X HOLD" appears on the unit's display.



If you press a button while the Child Lock is on, "X HOLD" appears on the unit's display and operation is impossible.

Tips

To cancel the Child Lock

Press and hold [OK] and [RETURN ↵] at the same time until "X HOLD" disappears.

Using the Unit's Remote Control to Operate the TV

You can configure the remote control TV operation buttons to turn the television on/off, change the television input mode, select the television channel and change the television volume.

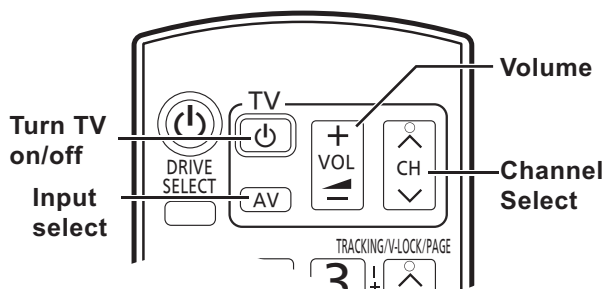

- 1 Point the remote control at the TV.
- 2 While pressing and holding [TV], enter the code from the table below using the numbered buttons.
e.g., 01: press [0] ⇒ [1]
- 3 Test the TV functions of the remote control for operability.
 - If the functions do not work, repeat steps 1 to 3 using different codes, if available. Some TVs may not be compatible with the unit's remote control.

Remote Control Codes for the TV

Manufacturer	Code No.
Panasonic	01/02/03/04
AIWA	35
AKAI	27/30
BEIJING	33
BEKO	05/71/72/73/74
BENQ	58/59
BP	09
BRANDT	10/15
BUSH	05
CENTREX	66
CHANGHONG	69
CURTIS	05
DAEWOO	64/65
DESMET	05
DUAL	05
ELEMIS	05
FERGUSON	10/34
FINLUX	61
FISHER	21

Manufacturer	Code No.
FUJITSU	53
FUNAI	63/67
GOLDSTAR	05/50/51
GOODMANS	05
GRADIENTE	36
GRUNDIG	09
HIKONA	52
HITACHI	05/22/23/40/41
INNO HIT	05
IRRADIO	30
ITT	25
JINGXING	49
JVC	17/30/39/70
KDS	52
KOLIN	45
KONKA	62
LG	05/50/51
LOEWE	07/46
MAG	52
METZ	05/28
mitsubishi	05/19/20/47
MIVAR	24
NEC	36
NOBLEX	33
NOKIA	25/26/27/60/61
NORDMENDE	10
OLEVIA	45
ONWA	30/39/70
ORION	05
PEONY	49/69
PHILCO	41/48/64
PHILIPS	05/06/46
PHONOLA	05
PIONEER	37/38
PROVIEW	52
PYE	05
RADIOLA	05
SABA	10
SALORA	26
SAMSUNG	32/42/43/65/68
SANSUI	05
SANYO	21/54/55/56
SCHNEIDER	05/29/30
SEG	05/69/75/76/77/78
SELECO	05/25
SHARP	18
SIEMENS	09
SINUDYNE	05
SONY	08
TCL	31/33/66/67/69
TELEFUNKEN	10/11/12/13/14
TEVION	52
TEX ONDA	52
THOMSON	10/15/44
TOSHIBA	16/57
WHITE WESTINGHOUSE	05
YAMAHA	18/41

Additional Connections

Using a fully wired 21-pin Scart cable

- You can use a variety of Q Link functions by connecting the unit to a Q Link compatible television (⇒ 46).
- You can enjoy high-quality viewing by connecting the unit to an RGB compatible television. "AV1 Output" in the Setup menu is set to "RGB 1" or "RGB 2" (⇒ 71). Make "AV2 Input" settings in the Setup menu (⇒ 71).

Use of the RF coaxial cable

- Keep the RF coaxial cables as far away as possible from other cables.
- Do not roll up the RF coaxial cables.

DVD output and DVD/VHS output

The unit has DVD/VHS common out terminals and DVD priority out terminals.

- The DVD priority out terminals can also output the VHS signal. However this is not possible during DVD recording or DVD timer recording.

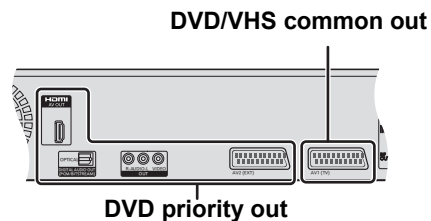

- Before connection, turn off the mains for all connected equipment and read the appropriate operating instructions.

Connect AC mains lead only after all other connections are complete.
BE SURE TO READ THE CAUTION FOR AC MAINS LEAD ON PAGE 3.

Adding a VCR: Connecting to a Television and a Video Cassette Recorder

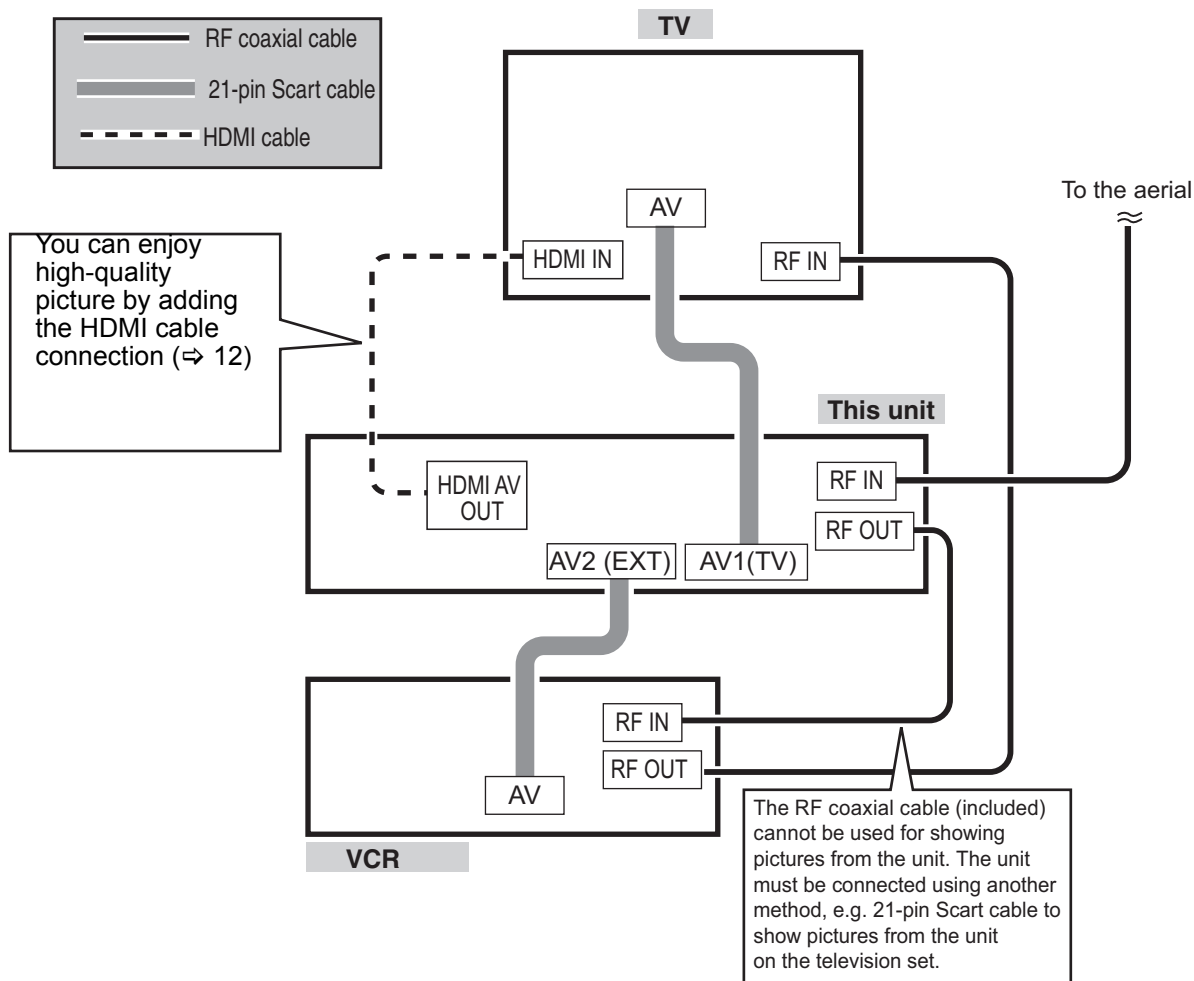

To record from a VCR

Refer to "Recording from an External Device" (⇒ 32).

Additional Connections

Connecting to a Television with Audio/Video Cable (not included)

- You can connect this unit to a TV using the audio/video (AV) cable, instead of the HDMI cable or 21-pin Scart cable (⇒ 10, 11, 75).
- Using a Scart or HDMI cable gives a higher quality picture than this connection.
- Connect to terminals of the same colour.

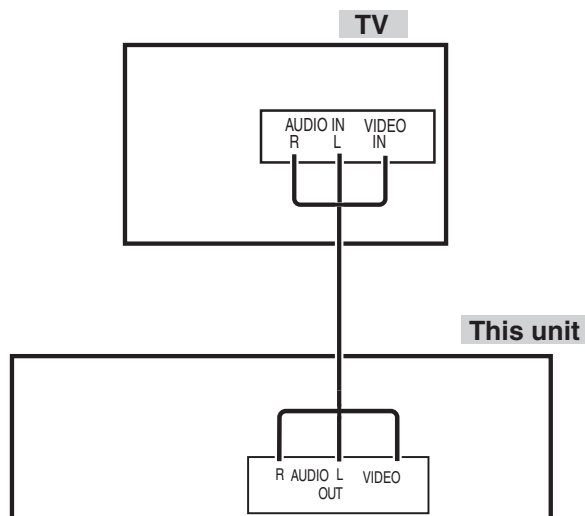

Adding an Amplifier or Receiver

You can improve sound quality by connecting this unit to an amplifier or system component using the audio cable or the optical digital audio cable.

Using an Audio Cable (not included)

It is possible to output 2-channel stereo sound.

- Connect to terminals of the same colour.

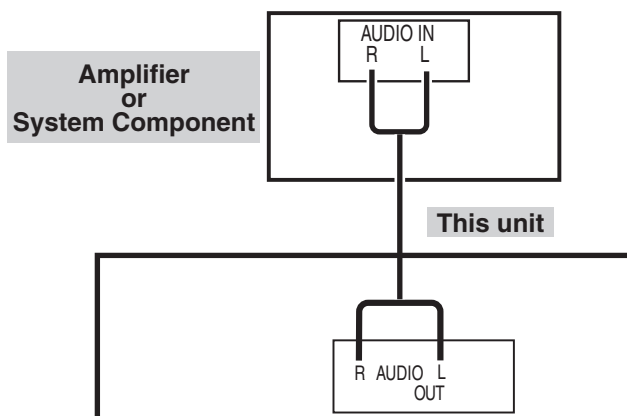

Using an Optical Digital Audio Cable (not included)

It is possible to output multi-channel surround sound on DVD-Video.

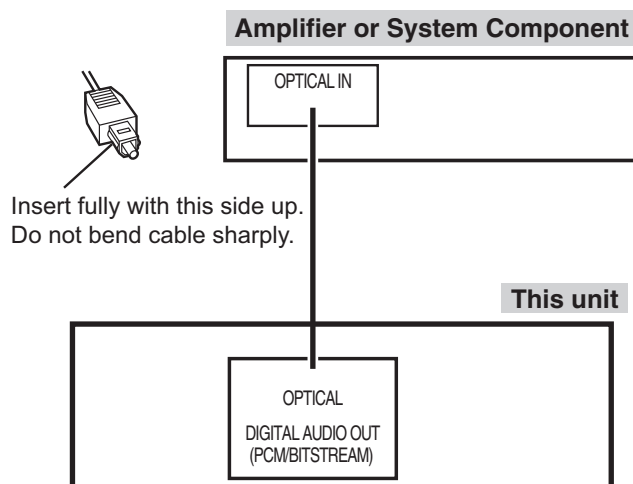

- Connect an amplifier or system component with a built-in Dolby Digital, DTS or MPEG decoder.
- Adjust settings in “Digital Audio Output” (⇒ 69) as needed, depending on other connection and the amplifier or receiver.

Notes

- When this unit is connected to an amplifier with an optical digital audio cable and connected to a television with an HDMI cable, you can enjoy the highest quality of audio from the disc by setting “Digital Audio Output” to “Optical Only” in the Setup menu (⇒ 70). In this case audio is only output from the amplifier not the television.
- You cannot use DTS Digital Surround decoders not meant for DVD.
- Before purchasing an optical digital audio cable, check the terminal shape of the equipment to be connected.

Connecting with an HDMI (High Definition Multimedia Interface) Terminal

When connected to an HDMI compatible unit, an uncompressed digital audio and video signal is transmitted, enabling you to enjoy high quality, digital video and audio with just one cable. When connecting to an HDMI-compatible HDTV (High Definition Television), the output can be switched to 1080p, 1080i or 720p HD video.

- Please use High Speed HDMI Cables that have the HDMI logo (as shown on the cover).
- When setting video output to “1080p”, please use the HDMI cables 5.0 meters or less.

Regarding VIERA Link “HDAVI Control™” function

When connecting with a Panasonic TV (VIERA) or a receiver equipped with the “HDAVI Control” function, linked operations would be possible. [⇒ 46, Linked Operations with the TV (VIERA Link “HDAVI Control™/Q Link)]

- It is recommended that you use Panasonic’s HDMI cable.
Recommended part number: RP-CDHS15 (1.5 m), RP-CDHS30 (3.0 m), RP-CDHS50 (5.0 m), etc.
- Non-HDMI-compliant cables cannot be utilised.

Using an HDMI (High Definition Multimedia Interface) Cable (not included)

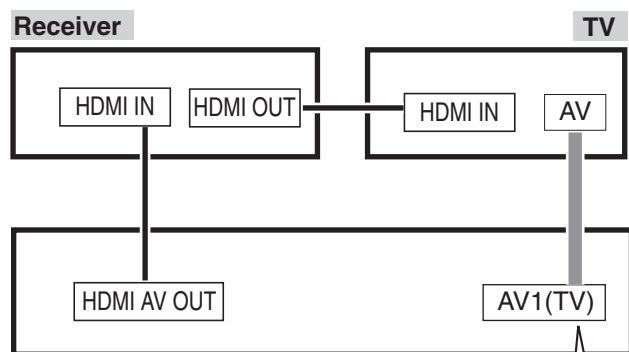

This unit

Connecting with a Panasonic TV (VIERA)

If the 21-pin Scart cable is connected, the following functions are available.

- Direct TV Recording (⇒ 29)

- Set “Digital Audio Output” to “HDMI and Optical” (⇒ 70).
(The default setting is “HDMI and Optical”.)

Notes

- If connecting to equipment that is only compatible with 2 channel audio output, audio with 3 channels or more will be down-mixed (⇒ 92) and output as 2 channels, even if connecting with an HDMI cable (some discs cannot be down-mixed).
- You cannot connect this unit to DVI devices that are incompatible with HDCP.
For display units compatible with HDCP (High-Bandwidth Digital Content Protection) that are equipped with a digital DVI input terminal (PC monitors, etc.):
Depending on the unit, picture may not be displayed properly or at all when connecting with a DVI/HDMI switching cable (audio cannot be output).

Frequently Asked Questions

Setup

How can I enjoy High Quality Video up-converted to 1080p?

- Connect the unit to 1080p compatible HDTV using an HDMI cable.
Set "HDMI Video Format" in the Setup menu to "1080p". (⇒ 12, 70)

What equipment is necessary to play multi-channel surround sound?

- You cannot playback multi-channel sound on this unit without other equipment. You must connect this unit with an HDMI cable or an optical digital cable to an amplifier with a built-in (Dolby Digital, DTS or MPEG) decoder and multi-channel speakers. (⇒ 76)

Can the headphones and speakers be directly connected to the unit?

- You cannot directly connect to the unit. Connect through the amplifier, TV, etc. (⇒ 76)

Is my TV compatible with progressive output?

- All Panasonic televisions that have 625 (576)/50i · 50p, 525 (480)/60i · 60p input terminals are compatible. Consult the manufacturer if you have another brand of TV.

Discs

Can I play DVD-Video, and Video CDs bought in another country?

- You cannot play DVD-Video if their region number does not include "2" or "ALL". Refer to the disc's jacket for more information. (⇒ Cover)

Can a DVD-Video that does not have a region number be played?

- Discs either without region encoding or region code 2 will not play on this unit.

Please tell me about disc compatibility with this unit.

- This unit records and plays DVD-RAM, DVD-R, DVD-R DL, DVD-RW (DVD-Video format), +R, +R DL and +RW, and plays DVD-RW (DVD Video Recording format). (⇒ 15, 16)
- This unit also records and plays high speed recording compatible discs. (⇒ 91)
- After recording but before finalising DVD-R, DVD-R DL, DVD-RW, +R and +R DL.
 - You may not be able to play and record discs on this unit after recording them on other Panasonic products or other manufacturers' equipment.
 - You may not be able to play and record discs on other equipment after recording them on this unit.After finalising the disc, however, you will be able to play it on any DVD-Video compatible player.

Please tell me about CD-R and CD-RW compatibility with this unit.

- This unit plays CD-R/CD-RW discs which have been recorded in one of the following standards: CD-DA, Video CD, SVCD (conforming to IEC62107), MP3 and still pictures (JPEG). Close the session or finalise the disc after recording. This unit can recognize up to 300 folders (groups or albums) and 3000 files (tracks) on a disc with MP3 or still pictures (JPEG). (⇒ 16, 18)
- You cannot write to a CD-R or CD-RW with the unit.

DVB-T

Which aerial is suitable for receiving digital terrestrial broadcasts?

- Any (terrestrial) roof aerial can be used. However, depending on the area where you live, a new aerial may be necessary. Consult your local TV aerial installer.

Can this unit receive or record High Definition (HD) broadcasts?

- No, this unit cannot receive or record High Definition (HD) broadcasts.

GUIDE Plus+

Is it possible to programme a recording, with a start and end time that are different from the GUIDE Plus+ system?

- You can manually change the start and end time of programmes in the Timer Recording menu. But if timings are altered by more than 10 minutes, "Guide Link" will not be able to function. (⇒ 23)

Can I receive GUIDE Plus+ system data via a connected digital satellite receiver or a Set Top Box?

- No, only via the built-in tuner. To perform timer recordings with digital satellite receivers or Set Top Boxes, please use the External Link feature or your unit's manual timer programming. (⇒ 31, 33)

How can I cancel a timer programming?

- Press [PROG/CHECK] and select the desired entry and then press [DELETE *]. (⇒ 34)

What happens when I unplug my unit from the household mains socket?

- The GUIDE Plus+ system data will not be updated. If the unit is disconnected from the AC mains for a longer period of time, then the GUIDE Plus+ data is lost. Display the GUIDE Plus+ screen. (⇒ 19, steps ①–②) The GUIDE Plus+ system data will then be automatically updated.

Recording

Can I record from a commercially purchased video cassette or DVD?

- Most commercially sold video cassettes and DVDs are copy protected; therefore, recording is usually not possible.

Can DVD-R, DVD-R DL, DVD-RW (DVD-Video format), +R, +R DL, and +RW recorded on the unit be played on other equipment?

- You can play these discs on compatible equipment such as DVD players after finalising the disc on this unit.
 - +RW** It is not necessary to finalise +RW. To enable play on other DVD players, please use "Create Top Menu" in the DVD Management menu. (⇒ 65)
- In any case, ability to play a disc depends on the condition of the recording, the quality of the disc, and the capability and format constraints of the DVD player.
- If you play a DVD-R DL, +R DL or +RW, use compatible equipment. Not all equipment will play those discs.

Can a digital audio signal from the unit be recorded to other equipment?

- You can record if using the PCM signal. When recording DVD, change the "Digital Audio Output" settings to the following via the Setup menu:
 - PCM Down Conversion: "On"
 - Dolby Digital: "PCM"
 - DTS: "PCM"
 - MPEG: "PCM"However, only
 - As long as digital recording from the disc is permitted.
 - As long as the recording equipment is compatible with 48 kHz sampling frequency. (⇒ 69)
- You cannot record MP3 signals.

USB

What can or cannot be done using the USB port on this unit?

- You can play MP3 or still picture (JPEG) files on a USB memory. (⇒ 42)
- You can copy still pictures (JPEG) files on a USB memory to DVD-RAM. (⇒ 60)
- Data on a disc cannot be transferred to a USB memory.
- Data on a USB memory cannot be edited or a USB memory cannot be formatted on this unit.
- Some USB memories cannot be used with this unit. (⇒ 17)
- This unit cannot be connected to a computer and it cannot record to an external device. i.e. an external hard drive via the USB port.

Messages

On the Unit's Display

H□□, F□□ (“□” stands for a service number.)	<ul style="list-style-type: none"> ● An error has occurred. The number following “H” or “F” depends on the status of the unit. Check the items below and in the Troubleshooting Guide. If the service number still does not disappear after the check, reset the unit (⇒ 82, To restore the unit if it freezes). ● If the service numbers fail to clear, note the service numbers and contact a qualified service person.
DVD □ (“□” stands for a number.)	<ul style="list-style-type: none"> ● The remote control and the main unit are using different codes. Change the code on the remote control. (⇒ 82)
GUIDE	<ul style="list-style-type: none"> ● GUIDE Plus+ data is being downloaded. (⇒ 73)
HARD ERR*	<ul style="list-style-type: none"> ● If there is no change after turning the unit on and off, consult the dealer where the unit was purchased.
NoCASSETTE*	<ul style="list-style-type: none"> ● You have not inserted a video cassette for the recording. (⇒ 7)
NoERAS	<ul style="list-style-type: none"> ● You cannot delete items on this disc. ● The disc may be damaged. Use a new disc.
NoREAD	<ul style="list-style-type: none"> ● The disc is dirty or badly scratched. The unit cannot record, play, or edit. (⇒ 7) ● The disc may be incompatible or of poor quality. (⇒ 15, 16) ● You have used a lens cleaner and it has finished operation. Press [▲ OPEN/CLOSE] on the main unit to eject the disc. (⇒ 6)
NoWRIT	<ul style="list-style-type: none"> ● You cannot write to this disc. ● The disc may be damaged. Use a new disc.
FINAL	<ul style="list-style-type: none"> ● When the screen asking if you want to finalise the disc appears, the message is displayed. (⇒ 29)
PLEASE WAIT*	<ul style="list-style-type: none"> ● Displayed when the unit is started. This is not a malfunction. ● The unit is carrying out its recovery process. You cannot operate the unit while the message is displayed.
PROG FULL*	<ul style="list-style-type: none"> ● There are already 16 timer recording programmes. Delete unnecessary timer recording programmes. (⇒ 34)
PROTECT*	<ul style="list-style-type: none"> ● You have inserted a video cassette without the accidental erasure prevention tab. Use a video cassette with an accidental erasure prevention tab. (⇒ 7)
REMOVE	<ul style="list-style-type: none"> ● The USB device is drawing too much power. Remove the USB device and turn the unit off.
SW-DL	<ul style="list-style-type: none"> ● The unit is performing a software update. (⇒ 73)
SP 35:50, LP 151h “SP”, “LP” and the numbers are examples.	<ul style="list-style-type: none"> ● Available space on the disc. ● The example “SP 35:50” is displayed when less than 100 hours are available and the example “LP 151h” is displayed when over 100 hours are available. ● “SP” and “LP” are recording modes, “35:50” means “35 hours 50 minutes” and “151h” means “151 hours”.
UNSUPPORT*	<ul style="list-style-type: none"> ● You have inserted a disc the unit cannot play or record onto. (⇒ 15, 16) ● You tried to operate with a non-compatible USB memory. (⇒ 17)
UNFORMAT*	<ul style="list-style-type: none"> ● You inserted an unformatted DVD-RAM, DVD-RW, +RW, an unused +R, +R DL or DVD-RW (DVD-Video format) that has been recorded on other equipment. ● Format the disc to use it. ● However all the recorded contents on the disc are deleted. (⇒ 29)
EXT-L	<ul style="list-style-type: none"> ● This unit is in EXT LINK standby. EXT LINK has been turned on and will stop operation on the unit until the recording has completed. ● Press [EXT LINK] to stop recording or cancel linked timer. (⇒ 31)

* The message are alternately displayed.

On the Unit's Display (Continued)

F74	<ul style="list-style-type: none"> The HDMI connection could not be authenticated due to a transfer malfunction. If you have another HDMI cable, try to use it. If it remains displayed, consult the dealer where the unit was purchased.
F75	<ul style="list-style-type: none"> The HDMI connection could not be authenticated due to an internal data malfunction. If you have another HDMI cable, try to use it. If it remains displayed, consult the dealer where the unit was purchased.
U59	<ul style="list-style-type: none"> The unit is hot. The unit switches to standby for safety reasons. Wait for about 30 minutes until the message disappears. Select a position with good ventilation when installing the unit. Do not block the cooling fan on the rear of the unit.
U61	<ul style="list-style-type: none"> (When a disc is not inserted) Displays when a malfunction has occurred. This is displayed when the unit is in the recovery process to return to normal operation. Once the display disappears you can use the unit again. If it remains displayed, consult the dealer where the unit was purchased.
U76	<ul style="list-style-type: none"> HDMI cannot be output because this unit is connected to a model that does not support copyright protection.
U80, U81, U99	<ul style="list-style-type: none"> The unit fails to operate properly. Press [⏻/I] on the main unit to switch the unit to standby mode. Press [⏻/I] on the main unit again to turn the unit on.
U88	<ul style="list-style-type: none"> There was something unusual detected with the disc while recording, playing or copying; there was a power failure or the AC mains lead was disconnected while the unit was on. The unit is carrying out its recovery process. This process restores the unit to normal operation. Wait until the message disappears. If it remains displayed, consult the dealer where the unit was purchased.
X HOLD	<ul style="list-style-type: none"> The Child Lock function is activated. Press and hold [OK] and [RETURN ↵] at the same time until "X HOLD" disappears. (⇒ 74)

On the TV

Cannot finish recording completely. Copy-protect signal was detected.	<ul style="list-style-type: none"> The programme was copy-protected.
Disc is full, or maximum number of titles are recorded. Cannot finish recording completely.	<ul style="list-style-type: none"> The disc may be full. The maximum number of title has been exceeded. (⇒ 28) RAM -RW(V) +RW Create space by erasing unwanted titles. Even if you erase recorded content from the DVD-R, DVD-R DL, +R or +R DL there is no increase in disc space. Available recording space on a DVD-RW (DVD-Video format) or +RW disc increases when the last title is deleted (space may increase slightly when you delete other titles). (⇒ 26, 50, 64) Use a new disc.
Cannot record. Maximum number of titles exceeded.	
No cassette.	<ul style="list-style-type: none"> There is no video cassette in the tape deck when playing or recording TV programmes. Insert a video cassette. (⇒ 7)
The cassette is write-protected.	<ul style="list-style-type: none"> A video cassette without a secure accidental erasure prevention tab is inserted when recording programmes. Use a video cassette with a secure accidental erasure prevention tab. (⇒ 7)
Cannot playback. TV system is different from the setting. To playback, please change the TV System in Setup.	<ul style="list-style-type: none"> You tried to play a title recorded using a different encoding system from that of the TV system currently selected on the unit. Alter the "TV System" setting on this unit to suit. (⇒ 70)
Cannot play on this unit.	<ul style="list-style-type: none"> You tried to play a non-compatible image. (⇒ 18)
No Disc	<ul style="list-style-type: none"> The disc is upside down. If it is a single-sided disc, insert it so the label is facing up. Ensure the disc is flat in the tray.
Now recording on DVD. To watch pictures on VHS, use AV1 socket, and switch to an appropriate AV channel on your TV.	<ul style="list-style-type: none"> The VHS plays back while recording on DVD. You can watch the VHS playback by connecting 21-pin Scart cable from AV1 on the unit to the television. VHS cannot be output via "DVD priority out" while recording to DVD. (⇒ 75)
This is a non-recordable disc.	<ul style="list-style-type: none"> The disc may be dirty or scratched. (⇒ 7) The unit cannot record on the disc you inserted. Insert a DVD-RAM or unfinalised DVD-R, DVD-R DL, DVD-RW (DVD-Video format), +R, R DL or +RW disc. (⇒ 15) You inserted an unformatted DVD-RAM, DVD-RW, +R, +R DL or +RW disc. Format the disc with the unit. (⇒ 64)
Unable to format.	
This disc is not formatted properly. Format it using DVD Management in FUNCTION MENU.	
⊘	<ul style="list-style-type: none"> The operation is prohibited by the unit, disc or video cassette.

Troubleshooting Guide

When Other Panasonic Products Respond to this Remote Control

Use this function to synchronize the codes for the remote control and the main unit when there are other Panasonic products close to your unit.

With the unit stopped

- 1 Press [FUNCTION MENU].
- 2 Press [▲, ▼] to select "Others", then press [OK].
- 3 Press [▲, ▼] to select "Setup", then press [OK].
- 4 Press [▲, ▼] to select "Others", then press [▶].
- 5 Press [▲, ▼] to select "Remote Control", then press [OK].
- 6 Press [▲, ▼] to select the code ("DVD 1", "DVD 2" or "DVD 3") and press [OK].

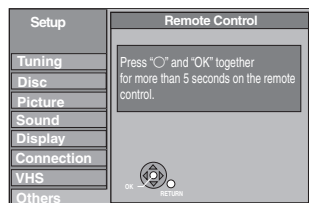

- 7 While pressing and holding [OK], press and hold the numbered button [1], [2] or [3] corresponding to the code set in step 6 for more than 5 seconds to set.
- 8 Press [OK] to complete.

When the following indicator appears on the unit's display



– Change the code on the remote control to match the code displayed for the main unit (⇒ step 7).

Tips

To return to the previous screen

Press [RETURN ↵].

To exit the screen

Press [EXIT].

To Reset This Unit

To reset the unit's settings

All the settings except for the ratings level, ratings PIN, Owner ID, Clock and remote control code, etc. return to the factory preset. The timer recording programmes are also cancelled.

When the unit is turned on and stopped.

Press and hold [▼ CH] and [CH ▲] on the main unit for about 5 seconds.

– The Auto-Setup starts automatically. (⇒ 13)

To reset the ratings level settings

With the unit is turned on and stopped

- 1 Press [▲ OPEN/CLOSE] to open the disc tray.
- 2 Press [DRIVE SELECT] to select the DVD drive.

On the main unit

- 3 Press and hold [● REC] and [▶] (PLAY) for about 5 seconds.

To restore the unit if it freezes

On the main unit

Press and hold [⏻/⏺] for more than 3 seconds.

– The unit is turned off.

Language code list

Enter the code with the numbered buttons.

Abkhazian: 6566	Catalan: 6765	Gujarati: 7185	Lingala: 7678	Rhaeto-Romance: 8277	Tamil: 8465
Afar: 6565	Chinese: 9072	Hausa: 7265	Lithuanian: 7684	Romanian: 8279	Tatar: 8484
Afrikaans: 6570	Corsican: 6779	Hebrew: 7387	Macedonian: 7775	Russian: 8285	Telugu: 8469
Albanian: 8381	Croatian: 7282	Hindi: 7273	Malagasy: 7771	Samoan: 8377	Thai: 8472
Amharic: 6577	Czech: 6783	Hungarian: 7285	Malay: 7783	Sanskrit: 8365	Tibetan: 6679
Arabic: 6582	Danish: 6865	Icelandic: 7383	Malayalam: 7776	Scots Gaelic: 7168	Tigrinya: 8473
Armenian: 7289	Dutch: 7876	Indonesian: 7378	Maltese: 7784	Serbian: 8382	Tonga: 8479
Assamese: 6583	English: 6978	Interlingua: 7365	Maori: 7773	Serbo-Croatian: 8372	Turkish: 8482
Aymara: 6589	Esperanto: 6979	Irish: 7165	Marathi: 7782	Shona: 8378	Turkmen: 8475
Azerbaijani: 6590	Estonian: 6984	Italian: 7384	Moldavian: 7779	Sindhi: 8368	Twì: 8487
Bashkir: 6665	Faroese: 7079	Japanese: 7465	Mongolian: 7778	Singhalese: 8373	Ukrainian: 8575
Basque: 6985	Fiji: 7074	Javanese: 7487	Nauru: 7865	Slovak: 8375	Urdu: 8582
Bengali; Bangla: 6678	Finnish: 7073	Kannada: 7578	Nepali: 7869	Slovenian: 8376	Uzbek: 8590
Bhutanì: 6890	French: 7082	Kashmiri: 7583	Norwegian: 7879	Somali: 8379	Vietnamese: 8673
Bihari: 6672	Frisian: 7089	Kazakh: 7575	Oriya: 7982	Spanish: 6983	Volapük: 8679
Breton: 6682	Galician: 7176	Kirghiz: 7589	Pashto, Pushto: 8083	Sundanese: 8385	Welsh: 6789
Bulgarian: 6671	Georgian: 7565	Korean: 7579	Persian: 7065	Swahili: 8387	Wolof: 8779
Burmese: 7789	German: 6869	Kurdish: 7585	Polish: 8076	Swedish: 8386	Xhosa: 8872
Byelorussian: 6669	Greek: 6976	Laotian: 7679	Portuguese: 8084	Tagalog: 8476	Yiddish: 7473
Cambodian: 7577	Greenlandic: 7576	Latin: 7665	Punjabi: 8065	Tajik: 8471	Yoruba: 8979
	Guarani: 7178	Latvian, Lettish: 7686	Quechua: 8185		Zulu: 9085

Before requesting service, make the following checks. If you are in doubt about some of the check points, or if the solutions indicated in the chart do not solve the problem, consult your dealer for instructions.

The following does not indicate a problem with the unit:

- Regular disc/video cassette rotating sound.
- Poor reception due to atmospheric conditions.
- Image disturbance during search.
- Periodic interruptions to the reception due to digital satellite broadcasting breaks.
- Operations are slow to respond when “Power Save in Standby” is activated.
- Operations are not working due to a poor-quality disc. (Try again using a Panasonic disc.)
- The unit freezing due to the activation of one of its safety devices (⇒ 82, To restore the unit if it freezes).
- When the unit is turned on or off, there may be an unexpected sound.

General Issues

Power

No power.

The unit does not turn on pressing [⏻].

- Insert the AC mains lead securely into a known active household mains socket. (⇒ 11)
- Linked timer recordings with external equipment is in recording standby (“EXT-L” on the unit’s display blinks when [⏻] is pressed). Press [EXT LINK] to cancel the recording standby. (⇒ 31)
- Check the fuse in the plug.

The unit switches to standby mode.

The unit is turned off automatically.

- One of the unit’s safety devices is activated. Press [⏻/I] on the main unit to turn the unit on.
- If you connected this unit to an “HDAVI Control” compatible TV with an HDMI cable, or connected this unit to a Q Link-compatible TV with a fully wired 21-pin Scart cable, this unit will be automatically set to standby mode when the TV is set to standby mode. (⇒ 46)

This unit turns off when the TV input is switched.

- This is a normal phenomenon when using VIERA Link (HDAVI Control 4 or later). For details please read the operating instructions for the TV.

General Issues

Displays

The display is dim.

- Change “Unit’s Display” in the Setup menu. (⇒ 69)

“0:00” is flashing on the unit’s display.

- Set the clock. (⇒ 14)

The time recorded on the disc and the available time shown do not add up.

The displayed time of this unit is different from the actual recording time or MP3 recording time.

- Times shown may disagree with actual times.
- **-R -R DL +R +R DL** The remaining capacity does not increase even if titles are deleted.
- Available space on a DVD-RW (DVD-Video format) or +RW disc increases when you delete the last title (space may increase slightly when you delete other titles).
- If you record or edit about 200 times or more, the remaining capacity of DVD-R, DVD-R DL, +R, and +R DL is reduced and then recording or editing may be disabled (for the second layer on DVD-R DL and +R DL, this happens after about 60 times).
- The time during searching may not be displayed accurately.

The clock is not correct.

- Under adverse reception conditions, etc., the automatic time correction function may not work. In this case, “Automatic” is automatically turned to “Off”. If re-setting the Auto Clock Setting does not work, set the time manually. (⇒ 14)

Compared to the actual recorded time, the elapsed time displayed is less.

(Only when recording in NTSC)

- The displayed recording/play time is converted from the number of frames at 29.97 frames (equal to 0.999 seconds) to one second. There will be a slight difference between the time displayed and the actual elapsed time (e.g., actual one-hour elapsed time may display as approximately 59 minutes 56 seconds). This does not affect the recording.

The tape counter is not changing.

- The tape counter does not change while playing unrecorded parts. The “second” display changes as follows: (e.g., Blank after 1 h 36 min)



- The unit’s display also appears like this if the tape is dirty or damaged. Consult your dealer if this is the case.

The clock does not display on the unit when switched to standby.

- Ensure “Power Save in Standby” is deactivated. (⇒ 72)

General Issues Operation

Cannot operate the TV with unit's remote control.

- Change the manufacturer code on the remote control. (⇒ 74)
- It may be necessary to set the code on the remote control again after changing the batteries. (⇒ 82)

Cannot operate the DVD.

- Press [DRIVE SELECT] to select the DVD drive when operating DVDs or CDs. (⇒ 20)

Cannot operate the VHS.

- Press [DRIVE SELECT] to select the VHS drive when operating video cassettes. (⇒ 20)

The remote control doesn't work.

- The remote control code is wrong. Change to the correct code. (⇒ 82)
- The batteries are depleted. Replace them with new ones. (⇒ 6)
- Point the remote control at the remote control sensor on the main unit. (⇒ 6)
- Remove obstacles between the remote control and the main unit.
- Remove dust from the transmission window and the unit's sensor.
- Coloured glass may obstruct the signal reception/transmission.
- Don't place the signal sensor in direct sunlight or in areas that may be subject to sun exposure.
- It may be necessary to set the manufacturer code again after changing the batteries. (⇒ 74)
- If the "X HOLD" is displayed on the unit's front display, the Child Lock function is activated. (⇒ 74)
- If the "EXT-L" is displayed on the unit's front display, Linked timer recordings with external equipment is in recording standby. (⇒ 31)

The unit is on but cannot be operated.

- Recording drive or playback drive has not been selected properly. (⇒ 20, 22)
- Some operations may be prohibited by the disc.
- The unit is warm ("U59" appears on the unit's display). Wait until "U59" disappears. (⇒ 81)
- One of the unit's safety devices may have been activated. Reset the unit as follows:
Press [⏻/|] on the main unit to switch to standby mode. If the unit doesn't switch to standby mode, reset the unit (⇒ 82, To restore the unit if it freezes).
- The unit cannot be operated while performing an update. "SW-DL" appears on the unit's display while it is updating. Please wait until the "SW-DL" disappears. (⇒ 73)

"U88" is displayed and the disc cannot be ejected.

- The unit is carrying out the recovery process. The disc may be defective. Do the following to eject the disc. Try another disc.
 - 1 Press [⏻/|] on the main unit to switch to standby mode. If the unit doesn't switch to standby mode, reset the unit (⇒ 82, To restore the unit if it freezes).
 - 2 While the unit is turned off, press and hold [■] and [CH ^] on the main unit at the same time for about 5 seconds. (Ejection may take extra time depending on discs.)

Cannot eject a disc.

- The unit is recording.
- The unit may have a problem. Eject the disc as in 2 left.
- Linked timer recordings with external equipment is in recording standby ("EXT-L" on the unit's display blinks when [⏻] is pressed.) Press [EXT LINK] to cancel the recording standby.
If the Child Lock function is activated, above operation does not work. Cancel the Child Lock function. (⇒ 31, 74)

Startup is slow.

- Startup takes time in the following situations:
 - A disc other than a DVD-RAM is inserted.
 - The clock is not set.
 - Immediately after a power failure or the AC mains lead is connected.
 - When the unit is connected with an HDMI cable.
- Deactivate "Power Save in Standby" in the Setup menu. (⇒ 72)

General Issues GUIDE Plus+

The GUIDE Plus+ system does not receive any data.

- Check whether the clock is properly set. (⇒ 14)
- If signal quality is bad (ghost images or limited reception), the GUIDE Plus+ system may not be able to receive any data.
- Perform "DVB Auto Setup by Signal Quality" in the Setup menu. (⇒ 67)

"No Data" is displayed for some or all stations.

- Some stations are not supported by the GUIDE Plus+ system.
- Programme the timer recording manually. (⇒ 33)
- Perform "DVB Auto Setup by Signal Quality" in the Setup menu. (⇒ 67)

The GUIDE Plus+ information is not displayed properly.

- There was a programme change or GUIDE Plus+ information from a broadcast station was possibly not correctly transmitted.
Check the current programme, e.g. on the Web site for the GUIDE Plus+ system provider or station provider.

The GUIDE Plus+ data is not updated.

- The unit must be in standby mode in order to update the data. If the unit is in EXT LINK mode ("EXT-L" lights up in the unit's display), then the data update may also not work.
- Make sure that the time is set correctly. (⇒ 14)
- Check whether "Off" is set under "TV Guide Download in Standby" and change the setting in "System Update" in the Setup menu. (⇒ 73)

General Issues DVB-T

Digital broadcasts cannot be received.

- Check the connections. (⇒ 10, 11, 75)
- Digital broadcast may not have started in your region yet.
- Perform "DVB Auto Setup by Signal Quality" in the Setup menu. (⇒ 67)

TV reception worsens after connecting the unit.

- This can occur because the signals are being divided between the unit and other equipment. It can be solved by using a signal booster, available from electronics retailers.

After "DVB Auto Setup by Signal Quality" or "DVB Auto Setup by Region" only some or no DVB channels are found.

- Check to ensure your area is covered by DVB transmissions.
- Check that the aerial and antenna cable are designed for DVB.
- Perform "DVB Auto Setup by Signal Quality" in the Setup menu. (⇒ 67)

Picture regularly breaks up on some channels, "No Signal" message is displayed.

- Check "Signal Condition". If "Signal Quality" or "Signal Strength" are displayed in red or constantly changing, check aerial. If problem persists consult your local TV aerial installer. (⇒ 67)
- Check that the aerial and antenna cable are designed for DVB.
- Interference (known as impulse noise) from household appliances such as light switches, fridges, etc. may cause picture break up and/or audio distortion. Use a high quality quad shielded coaxial cable fly lead between this unit and antenna wall socket to minimise impulse noise pickup. If problem persists consult your local TV aerial installer.
- Check aerial connection.
- Adjust the aerial reception with "DVB Manual Tuning". (⇒ 67)
- Perform "DVB Auto Setup by Signal Quality" in the Setup menu. (⇒ 67)

Picture very infrequently breaks up on some or all channels.

- Electrical atmospheric interference caused by local or distant lightning storms or heavy rain with wind in "leafy" locations may cause pictures to break up and audio to mute or distort momentarily.
- Impulse noise interference from an infrequently used electrical appliance, or a passing vehicle or lawn mower with a "noisy" ignition system.
- Perform "DVB Auto Setup by Signal Quality" in the Setup menu. (⇒ 67)

Unusual station sorting.

- The station sorting of this unit is pre-defined. Use Favourites to sort the stations as you want them. (⇒ 66)

The digital channel information does not appear.

- Select the length of time (3–10 sec.) in the "On-Screen Messages" in the Setup menu. (⇒ 69)
- The digital channel information will not appear during playback or recording.
- Perform "DVB Auto Setup by Signal Quality" in the Setup menu. (⇒ 67)

No Digital Teletext

- Not all functions of Digital Teletext work on this unit.
- When subtitle is on or additional information in the digital channel information is displayed, Digital Teletext does not work.
- Perform "DVB Auto Setup by Signal Quality" in the Setup menu. (⇒ 67)

After the Auto-Setup, there aren't any stations in the station list although found stations were displayed during Auto-Setup.

- "Shipping Condition" was performed or the unit was in the delivery status. The Auto-Setup was then started and interrupted. Do an Auto-Setup again and let it continue right through to the end. The data is only saved after this has been completed.

The Signal Strength is over 100% (> 10)

- Reduce the signal amplification at your aerial. (⇒ 67)

After performing an update, you can no longer receive broadcasts.

- Depending on the content of the software update, some settings may have returned to the preset values. Perform "Shipping Condition" in the Setup menu and then set the channel. (⇒ 67, 73)

General Issues VIERA Link

VIERA Link doesn't work.

- Check the HDMI cable connection. Check that "HDMI" is displayed on the front display when the unit is powering on.
- Make sure that "VIERA Link" is set to "On". (⇒ 70)
- Check the "HDAVI Control" settings on the connected device.
- Some functions may not work depending on the version of "HDAVI Control" of the connected equipment. This unit supports "HDAVI Control 5" function.
- If the connection for the equipment connected with an HDMI cable was changed, or if there was a power failure or the plug was removed from the household mains socket, "HDAVI Control" may not work. In this case, perform the following operations.
 - 1 When the HDMI cable is connected to all equipment with the power on, turn the TV (VIERA) on again.
 - 2 Change the TV (VIERA) settings for the "HDAVI Control" function to off, and then set to on again. (For more information, see the VIERA operating instructions.)
 - 3 Switch the VIERA input to HDMI connection with this unit, and after this unit's screen is displayed, check that "HDAVI Control" is working.

The Control Panel does not appear.

- The control panel is only displayed when connected to a TV with "HDAVI Control 2" or later function. (⇒ 47)

The operation on this unit (music playback etc.) is interrupted.

- The operation on this unit may be interrupted when you press buttons on the TV remote control that do not work for VIERA Link functions.

Troubleshooting Guide

General Issues USB

The contents of the USB memory cannot be read.

- Remove the USB memory from the USB port and then insert again. If this does not solve the problem, turn off and turn on the unit again.
- Check that the USB memory is inserted correctly. (⇒ 7)
- The format of the USB memory or of its contents is not compatible with the unit. (The contents on the USB memory may be damaged.) (⇒ 17, 18)
- The USB memory contains a folder structure and/or file extensions that are not compatible with this unit. (⇒ 18)
- Turn off and then turn on the unit again.
- USB memories connected using a USB extension cable or a USB hub may not be recognized by this unit.
- Some USB memories cannot be used with this unit. (⇒ 17)
- If inserted during playback, recording or copying etc., the USB memory may not be recognized by this unit.

Playback Issues Picture

The images from this unit do not appear on the TV. Picture is distorted.

- Make sure the connections are pushed in firmly. (⇒ 10, 11, 12, 75, 76, 77)
- Try connecting an alternative cable.
- Make sure recorder is connected to an appropriate AV input of the TV. (⇒ 10, 11, 12, 75, 76, 77)
- Make sure the TV's input setting (e.g., AV1) is correct.
- The TV isn't compatible with RGB signals.
Set "AV1 Output" in the Setup menu to "Video". (⇒ 71)
- The unit's "TV System" setting differs from the TV system used by the disc now playing. While stopped, keep pressing [■] and [▲ OPEN/CLOSE] on the main unit for 5 or more seconds.
The system switches from PAL to NTSC or vice versa. (⇒ 70)
- When this unit is connected with an HDMI cable, use a disc that matches with this unit's TV system.
- Picture may not be seen when more than 4 devices are connected with HDMI cables.
Reduce the number of connected devices.

Television reception worsens or becomes impossible after connecting the unit.

- This can occur because the signals are being divided between the unit and other equipment. It can be solved by using a signal booster, available from electronics retailers.
- Broadcast signals may not be output from this unit's RF OUT terminal. Select "On" in "RF OUT (Aerial Signal)" in the Setup menu. (⇒ 72)

Picture does not appear during timer recording.

- Timer recordings work regardless of whether the unit is on or off. To confirm the timer recording is going to work properly, turn the unit on.

The screen changes automatically.

- When "Screen Saver" in the Setup menu is set to "On", the display may turn to the screen saver mode automatically if there is no operation for 5 minutes or more. Press [OK] to return to the previous screen.
Set "Screen Saver" in the Setup menu to "Off" to turn off the screen saver function. (⇒ 69)

The 4:3 aspect ratio picture expands left and right. Screen size is wrong.

- If you connect an HDMI cable, set "Aspect for 4:3 Video" in the Setup menu to "16:9". (⇒ 70)
- Check the settings for "TV Aspect" in the Setup menu. (⇒ 70)

It may be possible to adjust the display mode on the TV. Refer to your television's operating instructions.

Titles recorded with 16:9 aspect are stretched vertically.

- 16:9 aspect programmes are recorded in 4:3 aspect in the following cases.
 - [R] [R DL] [RW(V)] If you recorded or copied using "EP" or "FR (recordings 5 hours or longer)" recording mode.
 - If you recorded or copied to a +R, +R DL or +RW.

It may be possible to adjust the display mode on the TV. Refer to your television's operating instructions.

There is a lot of after-image when playing video.

- Set "Playback NR" in the Picture menu to "Off". (⇒ 63)

There is no apparent change in picture quality when making adjustments in the Picture menu using the on-screen display.

- The effect cannot be seen with certain types of video.

Cannot see the beginning of the title played.

- (If connecting to a TV that supports VIERA Link with an HDMI cable)
When [▶] (PLAY) is pressed on this unit's remote control, but you may not be able to see the beginning of the title played until the picture is displayed on the TV. Using [◀◀], return to the beginning of the title.

The picture is distorted during play, or video will not play correctly.

- You may be playing a TV programme recorded with poor reception or unfavourable weather conditions.
- The picture may be distorted or a black screen may appear briefly between recorded titles in the following situations:
 - between titles recorded with different recording modes.
 - between scenes recorded with different aspect ratios.
 - between scenes recorded with different resolutions.
 - between playlist chapters.
- Make sure the connections are pushed in firmly. (⇒ 10, 11, 12, 75, 76, 77)
- Try connecting an alternative cable.

Playback Issues Sound

No sound.

Low volume.

Distorted sound.

Cannot hear the desired audio type.

- Check the connections and the “Digital Audio Output” settings. Check the input mode on the amplifier if you have connected one. (⇒ 10, 11, 12, 69, 70, 76)
- Check if TV is muted.
- Check if amplifier is muted.
- Sound is not output while fast-forwarding during chasing playback and simultaneous record and playback.
- The sound effects will not work when the bitstream signal is output from the HDMI AV OUT terminal or the DIGITAL AUDIO OUT terminal.
- Audio may not be heard when more than 4 devices are connected with HDMI cables. Reduce the number of connected devices.
- To output audio from a device connected with an HDMI cable, set “Digital Audio Output” to “HDMI and Optical” in the Setup menu. (⇒ 70)
- Depending on the connected equipment, the sound may be distorted if this unit is connected with an HDMI cable.
- Make sure the connections are pushed in firmly. (⇒ 10, 11, 12, 75, 76, 77)
- Try connecting an alternative cable.

Cannot switch audio.

- You cannot switch the audio in the following cases.
 - When a DVD-R, DVD-R DL, DVD-RW (DVD-Video format), +R, +R DL or +RW disc is in the disc tray while DVD drive is selected.
 - When the recording mode is XP and “Audio Mode for XP Recording” is set to “LPCM”. (⇒ 69)
- When recording a digital broadcast with multiple audio channels, this unit will record only the audio channel selected in “DVB Multi Audio” in the on-screen display. The audio channel cannot be switched during playback. (⇒ 63)
- You have used a digital connection. Set “Dolby Digital” to “PCM” or connect using audio cables (analogue connection). (⇒ 69, 76)
- There are discs whose audio cannot be changed due to how the disc was created.

Playback Issues Operation

Play fails to start even when [▶] (PLAY) is pressed. Play starts but then stops immediately.

- Insert the disc correctly with the label facing up. (⇒ 7)
- The disc is dirty, scratched or marked. (⇒ 7)
- You tried to play a blank disc or a disc that is unplayable on the unit. (⇒ 15, 16, 18)
- You tried to play a +RW that needs to be finalised on the equipment used for recording.
- When recording to DVD-RAM using EP (8 hours) mode, play may not be possible on DVD players that are compatible with DVD-RAM. In this case use EP (6 hours) mode. (⇒ 68)
- Make sure that the TV is turned on. If the menu or messages are displayed, follow the on-screen instructions.

Audio and video momentarily pause.

- This occurs between playlist chapters.
- This occurs as scenes change during Quick View (Play ×1.3).
- **-R DL +R DL** When playing a title recorded on both layers, the unit automatically switches between layers and plays the title in the same way as a normal programme. However, video and audio may momentarily cut out when the unit is switching layers.

DVD-Video is not played.

- Ensure the DVD-Video region number for the disc is correct, and the disc is not defective. (⇒ Cover)
- You have set a ratings level to limit DVD-Video play. Change this setting. (⇒ 68)

Alternative soundtrack and subtitles cannot be selected.

- The languages are not recorded on the disc.
- You may not be able to use the on-screen menus to change the soundtrack and subtitles on some discs. Use the disc’s menus to make changes. (⇒ 20)

No subtitles.

- Subtitles are not recorded on the disc.
- Turn the subtitles on. (⇒ 62)

Angle cannot be changed.

- This function depends on software availability. Angles can only be changed during scenes where different angles are recorded.

You have forgotten your ratings PIN.

- With the tray open, press [DRIVE SELECT] to select the DVD drive, then press and hold [● REC] and [▶] (PLAY) on the main unit simultaneously for about 5 or more seconds.

Quick View (Play ×1.3) does not work.

- This does not work when audio is other than Dolby Digital.
- This does not work while recording in XP or FR mode.

The resume play function does not work.

- Memorized positions are cancelled when
 - press [■] several times.
 - open the disc tray.
 - **CD VCD USB** turn off the unit.
 - if a recording or timer recording was executed.

The Video CD picture does not display properly.

- When connecting to Multi-system TV, select “NTSC” in “TV System” in the Setup menu. (⇒ 70)
- When connecting to PAL TV, the lower part of the picture cannot be displayed correctly during search.

Time Slip, Manual Skip, etc. does not work.

- These functions do not work with finalised discs.
- Time Slip does not work when the unit’s “TV System” settings are different from the title recorded on the disc. (⇒ 70)

Cannot see the beginning of the title played.

- (If connecting to a TV that supports VIERA Link with an HDMI cable)
When [▶] (PLAY) is pressed on this unit’s remote control, you may not be able to see the beginning of the title played until the picture is displayed on the TV. Using [◀◀], return to the beginning of the title.

Troubleshooting Guide

Playback Issues Music

ID3 tag of a MP3 file is not completely displayed.

- Only the track name (**USB**) can be displayed with this unit.

Playback Issues Still Pictures

Cannot display DIRECT NAVIGATOR screen.

- This screen cannot be displayed during recording or copy or while the unit is standing by for linked timer recording with external equipment.

Still pictures (JPEG) do not playback normally.

- The images that were edited on the PC, such as Progressive JPEG etc., may not playback. (⇒ 18)

Playback Issues VHS Picture

On-screen display indicators do not appear.

- Select a setting other than "Off" in "On-Screen Messages" in the Setup menu. (⇒ 41, 69)
 - Press [STATUS] to show the on-screen display indicators.

The grey background appears during playback.

- You are playing a blank or poor quality portion of the tape.
- You can damage the unit if you play dirty or damaged tapes and this can cause the grey background to appear.

Playback Issues VHS Sound

Cannot hear the desired audio type.

- Press and hold [STTL] for about 5 or more seconds to select the audio. (⇒ 41)

There is noise when playing a video tape.

- Adjust the tracking. (⇒ 41)
- The tape is old or damaged.

Playback Issues VHS Play

The playback screen flickers.

- The video head is dirty. (⇒ 6)
- The tape is old or damaged.
- Check the "SQPB" setting. (⇒ 71)

Recording Issues Recording/Timer Recording/Copying/External input

Cannot record.

Cannot copy.

- You haven't inserted a disc or the disc you inserted cannot be recorded on. Insert a disc the unit can record onto. (⇒ 15)
- **RAM -RW(V) +R +R DL +RW** The disc is unformatted. Format the disc. (⇒ 64)
- The disc is protected with the "DVD Management" settings. (⇒ 64)
- The accidental erasure prevention tab has been removed. Cover the hole with adhesive tape. (⇒ 7)
- Some programmes have limitations on the number of times they can be recorded (CPRM). (⇒ 27, 92)
- The disc is full or nearly full. Delete unneeded titles (**RAM -RW(V) +RW**) or use another disc. (⇒ 26, 50, 64)
- You cannot record and copy on finalised DVD-R, DVD-R DL, DVD-RW (DVD-Video format), +R, +R DL discs. However, you can record and copy again if you format DVD-RW.
- If you repeatedly insert discs or turn the unit on and off about 50 times or more, the recording or editing of DVD-R, DVD-R DL, DVD-RW (DVD-Video format), +R, +R DL, and +RW discs may be disabled.
- DVD-R, DVD-R DL, DVD-RW (DVD-Video format), +R, +R DL and +RW discs recorded on this unit may not be recordable on other Panasonic DVD Recorders.
- This unit cannot record NTSC signals to discs that already have PAL signal recordings. Play of discs recorded with both PAL and NTSC on another unit is not guaranteed. (⇒ 70)
- Some broadcasts are copyright protected. (⇒ 15, 27, 92)

Timer recording does not work properly.

- The timer programme is incorrect or different timer programme times overlap. Correct the programme. (⇒ 34)
- The programme is not in timer recording standby. ("⊙" in the timer recording list is not on.) (⇒ 34)
 - 1 Press [PROG/CHECK].
 - 2 Press [▲, ▼] to select the programme and press the "Red" button.
- The clock is not correct. Set the clock. (⇒ 14)
- The programme information in the GUIDE Plus+ system may not be correct. It is recommended to modify the start and end times to allow a margin of a few minutes. (⇒ 23)

Timer recording does not stop even when [■] is pressed.

- When using the linked timer recording with external equipment, press [EXT LINK]. ("EXT-L" on the unit's display disappears.) (⇒ 31)
- If you start recording immediately after turning on the unit while "Power Save in Standby" is not activated in the Setup menu (Quick Start mode), you cannot then stop recording for a few seconds.
- Make sure that the recording drive is selected. Press [DRIVE SELECT] to select the recording drive. (⇒ 22)

The timer programme remains even after recording finishes.

- The timer programme remains if set to daily or weekly timer recording. (⇒ 33, 34)

Part or all of a recorded title has been lost.

- If the power shuts down or the AC mains lead is disconnected from the household mains socket while recording or editing, the title may be lost or the disc may become unusable. We cannot offer any guarantee regarding lost titles or discs. You will have to format the disc (**RAM** **-RW(V)** **+RW**) or use a new disc. (⇒ 64)

Cannot copy VHS to DVD.

- The disc is protected with the “DVD Management” settings. (⇒ 64)
- Some video tapes on the market (including rental videos) are copy-protected to prevent illegal reproductions. Copy-protected video tapes cannot be properly recorded.
- You cannot copy using the One Touch Copying operation button while the FUNCTION MENU, the Timer Recording List screen, etc. are displayed.

Cannot copy DVD to VHS.

- A video cassette without the accidental erasure prevention tab is inserted. Use a video cassette with an accidental erasure prevention tab.
- Some DVDs on the market (including rental DVD) are copy-protected to prevent illegal reproductions. Copy-protected DVDs cannot be properly recorded.
- You cannot copy using the One Touch Copying operation button while the FUNCTION MENU, the Timer Recording List screen, etc. are displayed.

The sound level after editing is not equal on DVD and on VHS.

- The sound level on DVD and VHS may not match depending on the disc. When the sound level in a particular part of the sound source is soft or loud, the sound may be recorded loudly or softly on a video tape.

Stripe-shaped black noise is recorded.

- An external playback device is interfering with the TV because the device is too close to the TV. Move the device away from the TV.

The programme name and the recorded title do not match.

- There was a programme change after timer recording was set but the recorded title still has the old programme name.

An unusually loud sound is coming from the rotating DVD-R, etc.

- When recording to a DVD-R, DVD-R DL, DVD-RW (DVD-Video format), +R, +R DL and +RW the sound of the disc rotating may be louder than normal, however, this is not a problem.

Cannot record video or sound from the external device.

- The external device is not correctly connected. (⇒ 11, 12, 32, 75, 76)
- The proper external input channel (AV2 or AV3) is not selected. Press [INPUT SELECT] to change.

**“

- A video cassette is not inserted. Insert a video cassette with an accidental erasure prevention tab. (⇒ 7)
- The accidental erasure prevention tab has been removed. Cover the hole with adhesive tape. (⇒ 7)**

Troubleshooting Guide

Editing Issues

DVD

Cannot format.

- The disc is dirty. Wipe with a damp cloth and then wipe dry. (⇒ 7)
- Disc may be defective or of poor quality.
- You tried formatting a disc that is not compatible with the unit. (⇒ 15, 16, 64)

Cannot create chapters.

Cannot mark the start point or the end point during "Partial Delete" operation.

- The unit writes the chapter division information to the disc when you turn it off or remove the disc. The information is not written if there is an interruption in the power.
- These operations are not possible with still pictures.
- You cannot set points if they are too close to each other. You cannot set an end point before a start point.

Cannot delete chapters.

- **RAM** When the chapter is too short to delete, use "Combine Chapters" to make the chapter longer. (⇒ 52)

The available recording time doesn't increase even after deleting titles on the disc.

- Available space on DVD-R, DVD-R DL, +R, or +R DL does not increase even after deleting previous titles.
- Available space on DVD-RW (DVD-Video format) or +RW increases when you delete the last title.

Cannot create a playlist.

- You cannot select all the chapters at once in a title if the title also includes still pictures. Select them individually.

Editing Issues

Still Pictures

Copying, deleting, and setting protection takes a long time.

- When there are a lot of folders and files, it may sometimes take a few hours.
- When repeating copying or deleting, it may sometimes take a long time. Format the disc. (⇒ 64)

Specifications

Power supply:	AC 220 V to 240 V, 50 Hz
Power consumption:	Approx. 34 W
Standby mode:	("Power Save in Standby" is activated and "RF OUT (Aerial Signal)" is set to "Off") ("Power Save in Standby" is not activated)
	Approx. 0.5 W
	Approx. 14 W

Recordable discs:

DVD-RAM:	2X SPEED (Ver. 2.0), 2–3X SPEED (Ver. 2.1) 2–5X SPEED (Ver. 2.2)
DVD-R (SL):	1X SPEED (Ver. 2.0), 1–4X SPEED (Ver. 2.0) 1–8X SPEED (Ver. 2.0), 1–16X SPEED (Ver. 2.1)
DVD-R (DL):	2–4X SPEED (Ver. 3.0), 2–8X SPEED (Ver. 3.0)
DVD-RW:	1X SPEED (Ver. 1.1), 1–2X SPEED (Ver. 1.1) 2–4X SPEED (Ver. 1.2), 2–6X SPEED (Ver. 1.2)
+R (SL):	2.4X SPEED (Ver. 1.0), 2.4–4X SPEED (Ver. 1.1) 2.4–8X SPEED (Ver. 1.2) 2.4–16X SPEED (Ver. 1.3)
+R (DL):	2.4X SPEED (Ver. 1.0), 2.4–8X SPEED (Ver. 1.1)
+RW:	2.4X SPEED (Ver. 1.1), 2.4–4X SPEED (Ver. 1.2)

Recording system:

DVD-RAM:	DVD Video Recording format
DVD-R:	DVD-Video format
DVD-R DL (Dual Layer):	DVD-Video format
DVD-RW:	DVD-Video format
+R	
+R DL (Double Layer)	
+RW	

Recording time:

Max. 8 hours (using 4.7 GB disc)	
XP: Approx. 1 hour	SP: Approx. 2 hours
LP: Approx. 4 hours	EP: Approx. 6 hours or 8 hours

Playable discs:

DVD-RAM:	DVD Video Recording format, JPEG
DVD-R:	DVD-Video format, MP3*1, JPEG*1
DVD-R DL (Dual Layer):	DVD-Video format, MP3*1, JPEG*1
DVD-RW:	DVD Video Recording format, DVD-Video format
+R	
+R DL (Double Layer)	
+RW	
DVD-Video, CD-Audio (CD-DA), Video CD, SVCD*2	
CD-R/CD-RW:	CD-DA*1, Video CD*1, SVCD*1, *2, MP3*1, JPEG*1

Optical pick-up:

System with 1 lens, 2 integration units
(662 nm wavelength for DVDs, 780 nm wavelength for CDs)

LASER Specification

Class 1 LASER Product	
Wave Length:	780 nm (CDs) 662 nm (DVDs)
Laser Power:	No hazardous radiation is emitted with the safety protection

Television system

Tuner System:	DVB-T
Channel Coverage:	UK
UHF:	21 to 68 ch
RF converter output:	Not provided

Video

Video system:	PAL colour signal, 625 lines, 50 fields NTSC colour signal, 525 lines, 60 fields
Recording system:	MPEG2 (Hybrid VBR)
Video In (PAL/NTSC):	AV1/AV2 (21 pin), AV3 (pin jack) 1 Vp-p 75 Ω, termination
S-Video In (PAL/NTSC):	AV2 (21 pin), AV3 (S terminal) 1 Vp-p 75 Ω, termination
RGB In (PAL):	AV2 (21pin) 0.7 Vp-p (PAL) 75 Ω, termination
Video Out (PAL/NTSC):	AV1/AV2 (21 pin), Video Out (pin jack) 1 Vp-p 75 Ω, termination
RGB Out (PAL/NTSC):	AV1 (21 pin), 0.7 Vp-p (PAL) 75 Ω, termination

VHS

Recording format:	VHS Video Cassette System Standard with FM audio
Heads:	4 Helical Scan Heads for Video 2 Helical Scan Heads for FM audio 1 Fixed Head for Normal audio
Tape Speed/Recording Time (with E-240 tape):	SP: 23.39 mm/s, 240 min LP: 11.7 mm/s, 480 min EP: 7.8 mm/s, 720 min
PAL:	SP: 33.35 mm/s, 168 min EP: 11.12 mm/s, 505 min
NTSC:	

Audio

Recording system:	Dolby Digital 2 ch, Linear PCM (XP mode)
Audio In:	AV1/AV2 (21 pin), AV3 (pin jack)
Input Level:	Standard: 0.5 Vrms, Full scale: 2.0 Vrms at 1 kHz
Input Impedance:	More than 10 kΩ
Audio Out:	AV1/AV2 (21 pin), Audio Out (pin jack)
Output Level:	Standard: 0.5 Vrms, Full scale: 2.0 Vrms at 1 kHz
Output Impedance:	Less than 1 kΩ
Digital Audio Out:	Optical terminal (PCM, Dolby Digital, DTS, MPEG)

USB

USB port:	Type A: 1 pc
USB standard:	USB 2.0 High Speed
Format:	FAT16, FAT32

HDMI Output:

19 pin type A: 1pc
HDMI™ (V.1.3a with Deep Colour)

This unit supports "HDAVI Control 5" function.

Others

Regional Code:	# 2
Operating temperature range:	5 °C to 40 °C
Operating humidity range:	10 % to 80 % RH (no condensation)
Dimensions (W×H×D):	430 mm×84 mm×335 mm (excluding the projecting parts) 430 mm×84 mm×346 mm (including the projecting parts)
Mass:	Approx. 5.4kg

*1 Finalising is necessary for compatible playback.

*2 Conforming to IEC62107

This unit is not compatible with "Chaoji Video CD" available on the market including CVD, DVCD and SVCD that do not conform to IEC62107.

Notes

- Specifications are subject to change without notice.

Glossary

Bitstream

This is a signal compressed and converted into digital form. It is converted back to a multi-channel audio signal, e.g., 5.1-channel, by a decoder.

CPRM (Content Protection for Recordable Media)

CPRM is technology used to protect broadcasts that are allowed to be recorded only once. Such broadcasts can be recorded only with CPRM-compatible recorders and discs.

Decoder

A decoder restores the coded audio signals on DVDs to normal. This is called decoding.

Deep Colour

This unit incorporates HDMI (V.1.3a with Deep Colour) technology that can reproduce greater colour gradation (4096 steps) when connected to a compatible TV.

You can enjoy exceptionally rich, natural-looking colours, with smooth, detailed gradation and minimal colour banding.

[A lower colour gradation (256 steps), without Deep Colour, will be reproduced if connected to a TV which does not support Deep Colour. The unit will automatically set appropriate output to suit the connected TV.]

Dolby Digital

This is a method of coding digital signals developed by Dolby Laboratories. Apart from stereo (2 channel) audio, these signals can also be multi-channel audio. A large amount of audio information can be recorded on one disc using this method.

When recording on this unit Dolby Digital (2 channel) is the default audio.

Down-mixing

This is the process of remixing the multi-channel audio found on some discs into two channels. It is useful when you want to listen to the 5.1-channel audio recorded on DVDs through your TV's speakers. Some discs prohibit down-mixing. If this is the case, this unit can only output the front two channels.

Drive

In the instance of this unit, this refers to the disc (DVD) and video cassette (VHS). These perform the reading and writing of data.

DTS (Digital Theater Systems)

This surround system is used in many movie theaters. There is good separation between the channels, so realistic sound effects are possible.

Dynamic range

Dynamic range is the difference between the lowest level of sound that can be heard above the noise of the equipment and the highest level of sound before distortion occurs. Dynamic range compression means reducing the gap between the loudest and softest sounds. This means you can hear dialogue clearly at low volume.

Film and Video

DVD-Video are recorded using either film or video. The unit can determine which type has been used, then uses the most suitable method of progressive output.

Film:	Recorded at 25 frames per second (PAL discs) or 24 frames per second (NTSC discs). (NTSC discs recorded at 30 frames per second as well.) Generally appropriate for motion picture films.
Video:	Recorded at 25 frames/50 fields per second (PAL discs) or 30 frames/60 fields per second (NTSC discs). Generally appropriate for TV drama programmes or animation.

Finalise

A process that makes play of a recorded CD-R, CD-RW, DVD-R, etc. possible on equipment that can play such media. You can finalise DVD-R, DVD-R DL, DVD-RW (DVD-Video format), +R, and +R DL on the unit. After finalising, the disc becomes play-only and you can no longer record or edit. However, finalised DVD-RW can be formatted to become recordable.

Folder

This is a place on the disc where groups of data are stored together. In the case of this unit, it refers to the place where still pictures (JPEG) are stored.

Formatting

Formatting is the process of making media such as DVD-RAM recordable on recording equipment. You can format DVD-RAM, DVD-RW (only as DVD-Video format) and +RW or unused +R and +R DL on this unit. Formatting irrevocably erases all contents.

Frame and Field

Frame refers to the single images that constitute the video you see on your TV. Each frame consists of 2 fields.

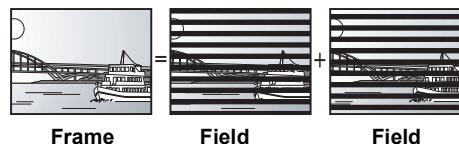

- A frame still shows 2 fields, so there may be some blurring between them, but picture quality is generally better.
- A field still shows less picture information so it may be rougher, but there is no blurring.

HDMI (High-Definition Multimedia Interface)

Unlike conventional connections, it transmits uncompressed digital video and audio signals on a single cable. This unit supports high-definition video output [720p (750p), 1080i (1125i) and 1080p (1125p)] from HDMI AV OUT terminal. To enjoy high-definition video a high definition compatible television is required.

JPEG (Joint Photographic Experts Group)

This is a system used for compressing/decoding color still pictures. If you select JPEG as the storage system on digital cameras, etc., the data will be compressed to 1/10–1/100 of its original size. The benefit of JPEG is less deterioration in picture quality considering the degree of compression.

LPCM (Linear PCM)

These are uncompressed digital signals, similar to those found on CDs.

MPEG2 (Moving Picture Experts Group)

A standard for efficiently compressing and expanding colour video. MPEG2 is a compression standard used for DVD and satellite based digital broadcasting. This unit records programmes using MPEG2.

MP3 (MPEG Audio Layer 3)

An audio compression method that compresses audio to approximately 1/10 of its size without any significant loss of audio quality.

Pan & Scan/Letterbox

In general, DVD-Video are produced with the intention that they will be viewed on a widescreen TV (16:9 aspect ratio), so images often don't fit regular TVs (4:3 aspect ratio). 2 styles of picture, "Pan & Scan" and "Letterbox", deal with this problem.

Pan & Scan: The sides are cut off so the picture fills the screen.



Letterbox: Black bands appear at the top and bottom of the picture so the picture itself appears in an aspect ratio of 16:9.



Playback control (PBC)

If a Video CD has playback control, you can select scenes and information with menus on the screen. (This unit is compatible with version 2.0 and 1.1.)

Protection

You can prevent accidental erasure by setting writing protection or erasure protection.

RGB

This refers to the three primary colours of light, red (R), green (G), and blue (B) and also the method of producing video that uses them. By dividing the video signal into the three colours for transmission, noise is reduced for even higher quality images.

Sampling frequency

Sampling is the process of converting the heights of sound wave (analogue signal) samples taken at set periods into digits (digital encoding). Sampling frequency is the number of samples taken per second, so larger numbers mean more faithful reproduction of the original sound.

Signal Quality

This is the guide for checking the aerial direction. The numbered values displayed do not indicate the strength of the signal, but the quality of the signal (the signal to noise ratio, or "S/N"). The channels you can receive are affected by weather conditions, seasons, time (day/night), region, length of the cable that is connected to the aerial, etc.

Thumbnail

This refers to a miniature representation of a picture used to display multiple pictures in the form of a matrix.

1080i

In one high-definition image, 1080 (1125) alternating scan lines pass every 1/50th of a second to create an interlace image. Because 1080i (1125i) more than doubles current television broadcasts of 480i (525i), the detail is much clearer and creates a more realistic and rich image.

1080p

In one high-definition image, 1080 (1125) scan lines pass at the same time every 1/50th of a second to create a progressive image. Since progressive video does not alternate scan lines like interlace, there is a minimal amount of screen flicker.

720p

In one high-definition image, 720 (750) scan lines pass at the same time every 1/50th of a second to create a progressive image. Since progressive video does not alternate scan lines like interlace, there is a minimal amount of screen flicker.

GUIDE Plus+, SHOWVIEW are (1) registered trademarks or trademarks of, (2) manufactured under license from and (3) subject of various international patents and patent applications owned by, or licensed to, Gemstar-TV Guide International, Inc. and/or its related affiliates.

GEMSTAR-TV GUIDE INTERNATIONAL, INC. AND/OR ITS RELATED AFFILIATES ARE NOT IN ANY WAY LIABLE FOR THE ACCURACY OF THE PROGRAM SCHEDULE INFORMATION PROVIDED BY THE GUIDE PLUS+ SYSTEM. IN NO EVENT SHALL GEMSTAR-TV GUIDE INTERNATIONAL, INC. AND/OR ITS RELATED AFFILIATES BE LIABLE FOR ANY AMOUNTS REPRESENTING LOSS OF PROFITS, LOSS OF BUSINESS, OR INDIRECT, SPECIAL, OR CONSEQUENTIAL DAMAGES IN CONNECTION WITH THE PROVISION OR USE OF ANY INFORMATION, EQUIPMENT, OR SERVICES RELATING TO THE GUIDE PLUS+ SYSTEM.

<http://www.europe.guideplus.com/>

The recording and playback of content on this or any other device may require permission from the owner of the copyright or other such rights in that content. Panasonic has no authority to and does not grant you that permission and explicitly disclaims any right, ability or intention to obtain such permission on your behalf. It is your responsibility to ensure that your use of this or any other device complies with applicable copyright legislation in your country. Please refer to that legislation for more information on the relevant laws and regulations involved or contact the owner of the rights in the content you wish to record or playback.

CAUTION!

THIS PRODUCT UTILIZES A LASER.
USE OF CONTROLS OR ADJUSTMENTS OR PERFORMANCE OF PROCEDURES OTHER THAN THOSE SPECIFIED HEREIN MAY RESULT IN HAZARDOUS RADIATION EXPOSURE. DO NOT OPEN COVERS AND DO NOT REPAIR YOURSELF. REFER SERVICING TO QUALIFIED PERSONNEL.

CAUTION!

- DO NOT INSTALL OR PLACE THIS UNIT IN A BOOKCASE, BUILT-IN CABINET OR IN ANOTHER CONFINED SPACE. ENSURE THE UNIT IS WELL VENTILATED. TO PREVENT RISK OF ELECTRIC SHOCK OR FIRE HAZARD DUE TO OVERHEATING, ENSURE THAT CURTAINS AND ANY OTHER MATERIALS DO NOT OBSTRUCT THE VENTILATION VENTS.
- DO NOT OBSTRUCT THE UNIT'S VENTILATION OPENINGS WITH NEWSPAPERS, TABLECLOTHS, CURTAINS, AND SIMILAR ITEMS.
- DO NOT PLACE SOURCES OF NAKED FLAMES, SUCH AS LIGHTED CANDLES, ON THE UNIT.
- DISPOSE OF BATTERIES IN AN ENVIRONMENTALLY FRIENDLY MANNER.

WARNING:

TO REDUCE THE RISK OF FIRE, ELECTRIC SHOCK OR PRODUCT DAMAGE,

- DO NOT EXPOSE THIS APPARATUS TO RAIN, MOISTURE, DRIPPING OR SPLASHING AND THAT NO OBJECTS FILLED WITH LIQUIDS, SUCH AS VASES, SHALL BE PLACED ON THE APPARATUS.
- USE ONLY THE RECOMMENDED ACCESSORIES.
- DO NOT REMOVE THE COVER (OR BACK); THERE ARE NO USER SERVICEABLE PARTS INSIDE. REFER SERVICING TO QUALIFIED SERVICE PERSONNEL.

CAUTION

Danger of explosion if battery is incorrectly replaced. Replace only with the same or equivalent type recommended by the manufacturer. Dispose of used batteries according to the manufacturer's instructions.

THIS UNIT IS INTENDED FOR USE IN MODERATE CLIMATES.

This product may receive radio interference caused by mobile telephones during use. If such interference is apparent, please increase separation between the product and the mobile telephone.

The socket outlet shall be installed near the equipment and easily accessible.

The mains plug of the power supply cord shall remain readily operable.

To completely disconnect this apparatus from the AC Mains, disconnect the power supply cord plug from AC receptacle.



(Back of product)

DANGER - VISIBLE AND INVISIBLE LASER RADIATION WHEN OPEN. AVOID DIRECT EXPOSURE TO BEAM. FDA 21 CFR/Class IIIb	
CAUTION - CLASS 3B VISIBLE AND INVISIBLE LASER RADIATION WHEN OPEN. AVOID EXPOSURE TO THE BEAM. IEC60825-1 -A2/Class 3B	
ATTENTION - RAYONNEMENT LASER VISIBLE ET INVISIBLE, CLASSE 3B. EN CAS D'OUVERTURE, EVITER L'UNE EXPOSITION AU FAISCEAU.	
FORSIGTIG - SYNLIG OG USYNLIG LASERSTRÅLING KLASSE 3B. NÅR LAGET ER ÅBENT, UNDGÅ AT BLIVE UDSAT FOR STRÅLEN.	
VARO - AVATTAESSA OLET ALLTIINA LUKKAN 3B NÄKYVÄÄ JA NÄKYMÄTÖNTÄ LASERSÄTELYÄ. VARO ALTISTUMISTA SÄTEELLE.	
WARNING - CLASS 3B SYNLIIG OCH OSYNLIIG LASERSTRÅLNING NÄR DENNA DEL ÄR ÖPPNAD. UNDVIK EXPOSITION FÖR STRÅLEN.	
VORSICHT - SICHTBARE UND UNSICHTBARE LASERSTRÄHLUNG KLASSE 3B. WENN ABDECKUNG GEÖFFNET, NICHT DEM STRAHL AUSSETZEN.	
注意 - 打开时有可见及不可见激光辐射。避免光束照射。	
注意 - ここを開くと可視及び不可視レーザー光が出ます。ビームを見たり、触れたりしないでください。VQL1J70	

(Inside of product)

- For your safety, be sure not to connect or handle the equipment with wet hands.

Information for Users on Collection and Disposal of Old Equipment and used Batteries



These symbols on the products, packaging, and/or accompanying documents mean that used electrical and electronic products and batteries should not be mixed with general household waste.

For proper treatment, recovery and recycling of old products and used batteries, please take them to applicable collection points, in accordance with your national legislation and the Directives 2002/96/EC and 2006/66/EC. By disposing of these products and batteries correctly, you will help to save valuable resources and prevent any potential negative effects on human health and the environment which could otherwise arise from inappropriate waste handling.

For more information about collection and recycling of old products and batteries, please contact your local municipality, your waste disposal service or the point of sale where you purchased the items.

Penalties may be applicable for incorrect disposal of this waste, in accordance with national legislation.



For business users in the European Union

If you wish to discard electrical and electronic equipment, please contact your dealer or supplier for further information.

[Information on Disposal in other Countries outside the European Union]

These symbols are only valid in the European Union. If you wish to discard these items, please contact your local authorities or dealer and ask for the correct method of disposal.



Note for the battery symbol (bottom two symbol examples):

This symbol might be used in combination with a chemical symbol. In this case it complies with the requirement set by the Directive for the chemical involved.

Cd

Index

- A** Adjust the audio quality (Sound menu) 63
- Adjust the picture quality (Picture menu) 63
- Album (Still picture)
 - Edit 55
 - Play 43
- Angle 62
- Aspect 70
- Audio
 - Digital broadcast (DVB Multi Audio) 63, 67
 - Playback 41
- Audio Description 33, 48
- Auto Standby 72
- AV2 Settings 71
- C** Change Thumbnail 51
- Channel
 - Select 19
 - Settings 66–67
- Chapter 39, 52
- Chapter Creation 52, 68
- Chasing playback 30
- Child Lock 74
- Cleaning
 - Disc 7
 - Lens 6
 - Main unit 6
 - Video heads 6
- Clock Setting 14
- Connection
 - Aerial 10, 11, 75
 - Amplifier, system component, receiver 76
 - Digital satellite receiver 11, 12
 - HDMI 12, 77
 - Television 10–12, 75–77
 - Video cassette recorder 75
- Copy
 - Still picture 60
 - Title/Playlist 57–59
- Copy (playlist) 54
- CPRM 92
- Create Chapter 39, 52
- Create playlists 53
- D** Delete
 - Album (Still Picture) 55
 - All titles 64
 - Chapter 52, 54
 - Playlist 53
 - Title 26, 50
- Digital Audio Output settings 69, 70
- Digital broadcast
 - Digital channel information 48
 - DVB Multi Audio 48, 63, 67
 - DVB Subtitle 48, 67
 - New Channel 49, 69
 - Recording 22
 - Select the channel 19
 - Signal Condition 67
 - System Update 73
 - Timer 23
- DIRECT NAVIGATOR 38, 43, 50, 55
- Direct TV Recording 29
- Discs 15–16
- Display
 - Digital channel information 48
 - Status messages 49
- Divide Title 51
- DVB Multi Audio
 - Recording with selected audio 22, 33
 - Select audio 63, 67
- DVB Subtitle
 - Record with subtitle 22, 33
 - Select subtitle 67
 - Show subtitle 48
- E** Edit
 - Chapter 52
 - Playlist 53
 - Still picture 55
 - Title 50
- Enabling discs to be played on other equipment — Finalise 65
- F** Finalise 65, 92
- Format 64, 92
- FR (Flexible recording mode) 28, 30
- FREEVIEW 23
- FUNCTION MENU Display 45, 69
- G** GUIDE Plus+ 23, 36–37
- H** HDAVI Control 12, 46–47, 70, 77
- HDMI 12, 70, 77, 92
- I** Initialize 73
- J** JPEG 18, 43–44, 92
- L** Language
 - Code list 82
 - Disc menu 68
 - Soundtrack 62, 68
 - Subtitle 62, 68
- Linked timer recordings with external equipment (SKY Digital STB/digital satellite receiver) — EXT LINK 31, 71
- LPCM 69, 92
- M** Manual Skip 39
- Menu
 - JPEG 42
 - Music 42
 - Setup 66
- Mode
 - Recording 28
 - Still Mode 68
- Music
 - Play 42
- N** Name
 - Album (Still picture) 55
 - Disc 64
 - Entering text 49
 - Playlist 54
 - Title 33, 50
- New Channel 49, 69
- O** Owner ID 13
- P** Partial Delete 51
- Playlist 53
- Power Save in Standby 72
- Properties
 - Playlist 53
 - Still picture 44, 56
 - Title 50
- Protection
 - Album (Still picture) 56
 - Disc 64
 - Still picture 56
 - Title 51
- Q** Link 46
- Quick View 38
- R** Ratings level 68
- Recording
 - Aspect 27
 - Direct TV Recording 29
 - External Link 31, 32
 - Flexible Recording 30
 - Mode 28
 - Notes 27
 - Timer 23, 33–35
- Remaining tape time 41
- Remote control code 82
- Repeat Play 40, 63
- Resume play function 20
- S** Screen Saver 69
- Select channel 19
- Setup menu 66
- Signal Condition 67
- Simultaneous rec and play 30
- Slideshow 43–44
- Soundtrack 62, 68
- Still picture
 - Copy 60
 - Edit 55
 - Play 43
- Subtitle
 - Digital broadcast (DVB Subtitle) 22, 33, 48, 67
 - Disc 62, 68
- Subtitles 68
- Switch the audio/subtitles on the disc (Disc menu) 62
- System Update 73
- T** Time Slip 39
- Tuning 66–67
- U** USB
 - Copy (Still Picture) 60–61
 - Insert 7
 - Play 42
 - Supported formats 17
- V** VHS
 - Copy 24–25, 57–59
 - Insert 7
 - Jet Rewind 40
 - Play 21, 40–41
 - S-VHS Quasi Playback (SQPB) 40, 71
 - VHS Index Search System (VISS) 40
- VHS settings 71
- VIERA Link 12, 46–47, 70, 77

Environment friendly printed on chlorine free bleached paper.

Panasonic Corporation
 Web Site: <http://panasonic.net>

Pursuant to at the directive 2004/108/EC, article 9(2)
 Panasonic Testing Centre
 Panasonic Marketing Europe GmbH
 Winsbergring 15, 22525 Hamburg, Germany

© Panasonic Corporation 2009



VQT2J51



En

VQT2J51
 F1209KA0